

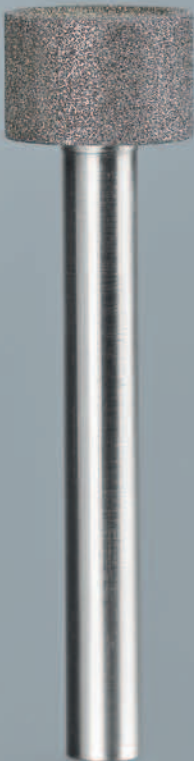

Diamond and CBN tools

5

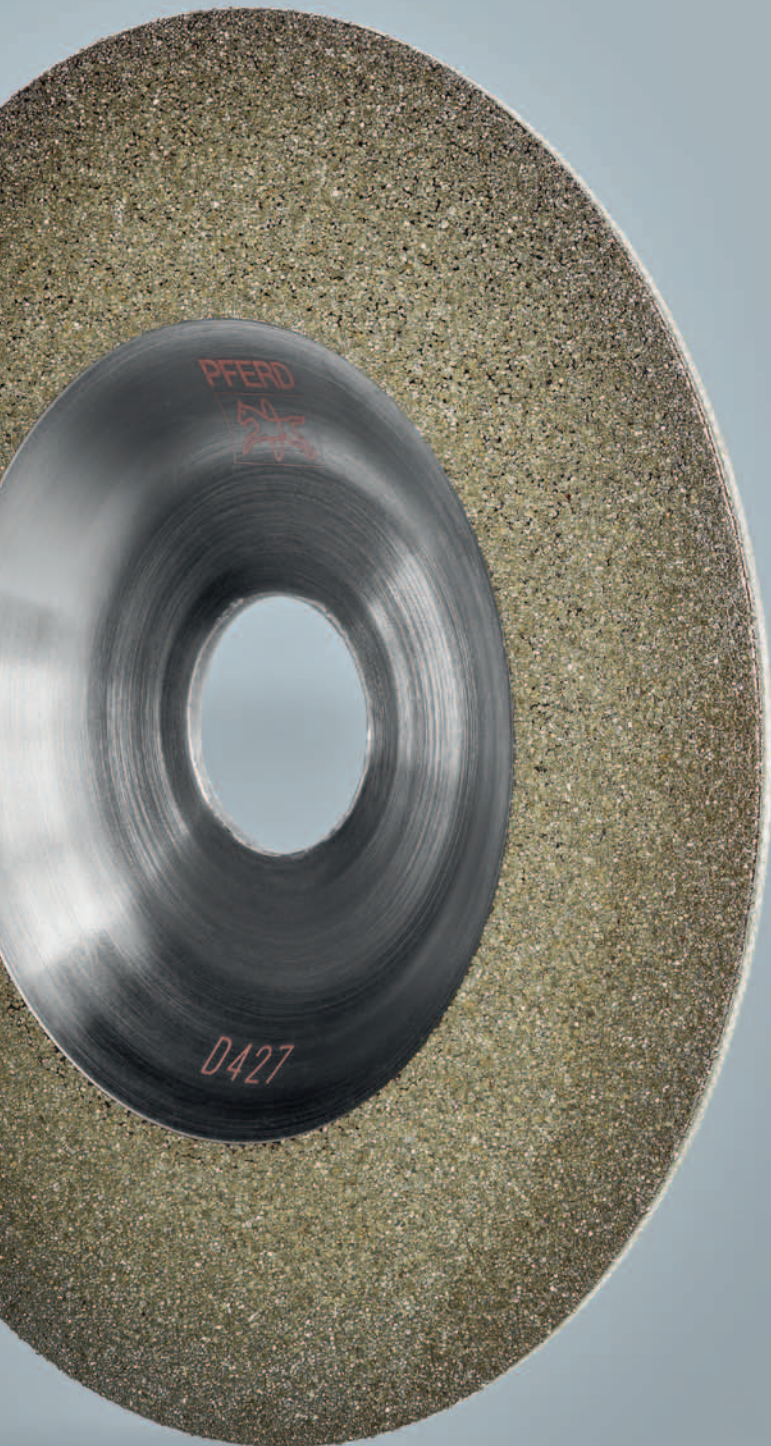

5



Diamond and CBN tools

Table of contents

General information	4
The fast way to the best tool	6
Abrasives, materials, grit sizes	8
Comparison of bond types	9
Recommended cutting speeds	10
Recommended rotational speed range and safety notes	11

Diamond and CBN tools – electroplated bond



Customer-specific tool solutions 14

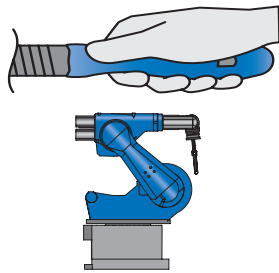
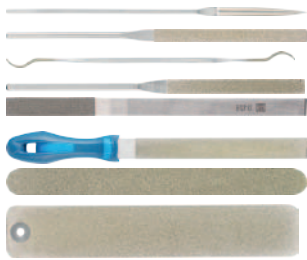

Diamond files

- Diamond escapement files 16
- Diamond needle files 17
- Diamond riffler files 18
- Diamond handy files 19
- Conical diamond files 19
- Diamond machinist's files 20
- Flexible diamond files 21
- Diamond sheets 21



- Diamond files for manual filing machines 22

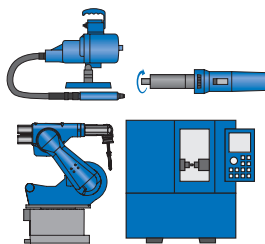

Diamond and CBN grinding points and grinding discs

- Diamond grinding points 24
- Diamond grinding discs 29
- CBN grinding points 30
- CBN grinding discs 33

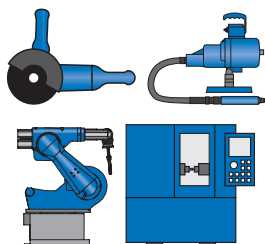

Diamond cut-off wheels

- Diamond cut-off wheels 34

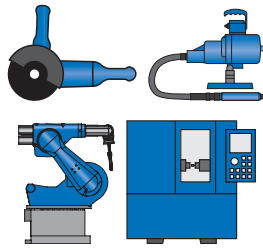
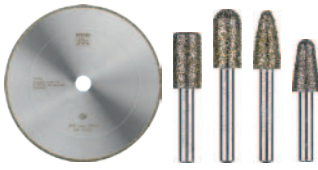

Diamond tools for foundries

- Diamond cut-off wheels for foundries 36
- Diamond grinding points for foundries 36

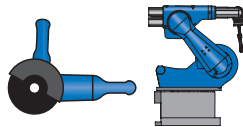
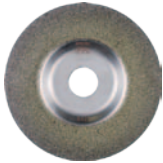

Diamond grinding discs

- Diamond grinding disc CC-GRIND-SOLID-DIAMOND 38

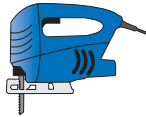

Diamond sabre saw blades

- Diamond sabre saw blades 38

Diamond and CBN tools – resinoid bond

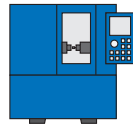
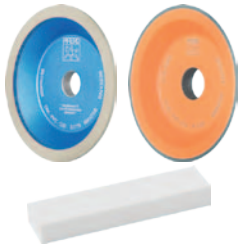

Diamond and CBN grinding tools

- Diamond grinding tools 41
- CBN grinding tools 42
- Sharpening block 43
- Customer-specific tool solutions 44

Diamond cut-off wheels for the construction industry

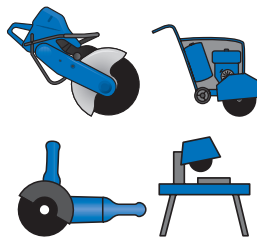
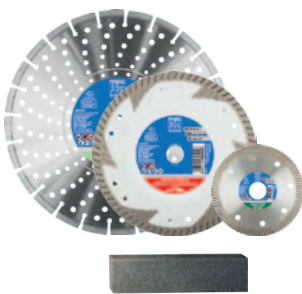

Diamond cut-off wheels

- Segmented type 50
- Continuous rim type (TURBO) 51
- Continuous rim type 52
- DSB sharpening block 52



Angle grinder



Machine tools



Filing machine



Straight grinder



Manual application files



Sabre saw



Table saw



Robot



Petrol cutter



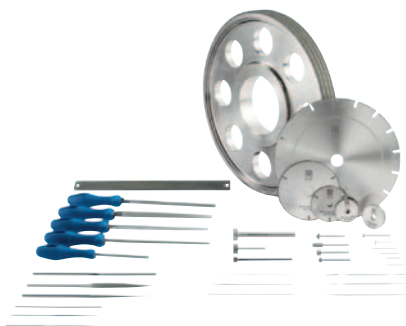

In use in many industries

The use of efficient tools for work on surfaces and cutting materials is an important factor for ensuring profitability in many processes and industries.

For many materials and applications, tools with super-hard abrasives like diamond or CBN (cubic boron nitride) abrasives provide a cost-effective alternative to conventional tools.

With their high hardness, they have a particularly long tool life and are an established problem-solver in many industries:

- Automotive industry and suppliers
- Energy industry
- Foundries (grey and nodular cast iron)
- Ceramic industry
- Plastics processing (GRP/CRP)
- Machine and plant construction
- Medical equipment
- Tool and mould construction
- Tool industry



PFERD quality

PFERD diamond and CBN grinding tools comply with the highest quality and safety requirements and are manufactured and labelled according to the European safety standard EN 13236.

In addition to the high quality standards, occupational health and safety as well as ergonomics play a prominent role.

PFERD quality management is certified according to ISO 9001.



PFERD TOOL-CENTER

On the TOOL-CENTER, the point of sale from PFERD, you will find all the important information required for selecting the most appropriate tool.

Your local retailer or PFERD sales representative will be glad to answer any questions you might have.



Packaging

Diamond and CBN tool packaging is matched to the requirements of the industry. It provides the tools with optimum protection against dirt and damage. The packaging units (PU) for the individual tools are listed in the product tables.

Diamond file sets and diamond machinist's files and sheets are supplied in practical, sturdy plastic boxes. These are ideal for storing the tools in the tool trolley or on the workbench.

Particularly large or heavy products made to order are supplied in sturdy wooden crates that protect the tools during transport.



All tools
and more information:
www.pferd.com

PFERDVALUE – Your added value with PFERD

Results from the PFERD test laboratories as well as from the product tests by independent testing institutes prove: PFERD tools offer measurable added value.

Discover **PFERDERGONOMICS** and **PFERDEFFICIENCY**:

As part of **PFERDERGONOMICS**, PFERD offers ergonomically optimized tools and tool drives that contribute to greater safety and working comfort, and thus to health protection.

As part of **PFERDEFFICIENCY**, PFERD offers innovative, high-performance tool solutions and tool drives with outstanding added value.



Electroplated diamond and CBN tools are characterized by low dust generation.

Diamond machinist's files are supplied with ergonomic file handles.

For more information on this topic, please refer to our brochure "PFERDVALUE – Your added value with PFERD".

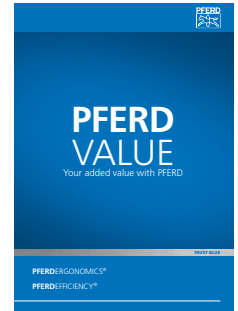

Associations

PFERD is an active member of the German Abrasives Association (VDS), the Federation of European Producers of Abrasives (FEPA) and the Organization for the Safety of Abrasives (oSa). The national and international activities of those associations include the areas of safety, standardization, classification and quality assurance.



Additional diamond tools with electroplated bonds in the PFERD product range

COMBIDISC diamond abrasive discs:

COMBIDISC is a comprehensive range for work on surfaces. COMBIDISC diamond abrasive discs are ideally suited for work on wear-resistant coatings and hard facings made from tungsten carbide, chromium carbide, titanium carbide, etc.

Diamond hand pads:

Diamond hand pads are ideally suited for grinding work on wear-resistant coatings and hard facings made from tungsten carbide, chromium carbide, titanium carbide, etc.



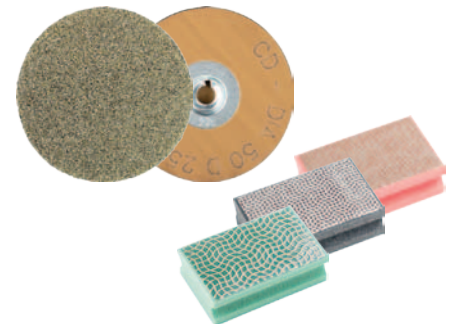

Further information and ordering data can be found in catalogue section 4.





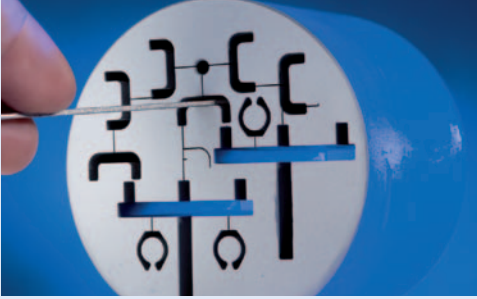
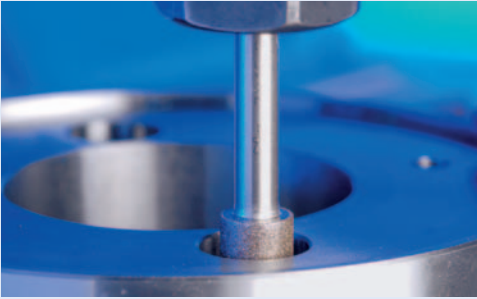









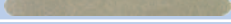
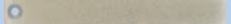







Diamond and CBN tools

The fast way to the best tool

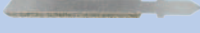

General application	Material	Application
Filing 	<ul style="list-style-type: none"> ■ Hardened steels ■ Tungsten carbide ■ Ceramic ■ Glass ■ Ferrite ■ Nickel- and titanium-based alloys 	Precision filing
		<ul style="list-style-type: none"> ■ Fibre-reinforced plastics (GRP/CRP)
Grinding   	<ul style="list-style-type: none"> ■ Tungsten carbide ■ Ceramic ■ Glass ■ Ferrite (magnetic material) ■ Nickel- and titanium-based alloys 	Grinding of bores, radii Grinding of contours, profiles and shoulders, as well as deburring and chamfering Internal grinding of bores
	<ul style="list-style-type: none"> ■ Tungsten carbide 	Sharpening of tungsten carbide tools
	<ul style="list-style-type: none"> ■ Hardened steel materials from approx. 54 HRC 	Grinding of bores, radii, contours, profiles and shoulders, as well as deburring and chamfering Internal grinding of bores
	<ul style="list-style-type: none"> ■ HSS (High Speed Steel) 	Sharpening of HSS tools
	<ul style="list-style-type: none"> ■ Fibre-reinforced plastics (GRP/CRP) 	Deburring, chamfering and general grinding work
<ul style="list-style-type: none"> ■ Grey and nodular cast iron 	Grinding burning-ins, sand inclusions and adhesions	
Cutting 	<ul style="list-style-type: none"> ■ Tungsten carbide ■ Ceramic ■ Glass ■ Ferrite ■ Nickel- and titanium-based alloys 	Cutting
	<ul style="list-style-type: none"> ■ Fibre-reinforced plastics (GRP/CRP) 	Cut-off grinding, trimming, making cut-outs and cutting straight contours to size Sawing, trimming, making cut-outs and cutting curved contours to size
	<ul style="list-style-type: none"> ■ Grey and nodular cast iron 	Separation of open risers, burrs, feeders, sprues, parting lines, etc.

You can find diamond cut-off wheels for the construction industry on page 48.

Tools		Page
Diamond files		16
Diamond files for air-powered filing machines		22
Flexible diamond files		21
Diamond sheets		21
Diamond machinist's files, grit size D251		20
Electroplated diamond grinding points		24
Diamond grinding disc CC-GRIND-SOLID-DIAMOND		38
Electroplated diamond grinding points, cylindrical shape ZY		24
Electroplated diamond grinding discs		29
Resinoid-bonded diamond grinding discs		40
Electroplated CBN grinding points		30
Electroplated CBN grinding points, cylindrical shape ZY		30
Electroplated CBN grinding discs		33
Resinoid-bonded CBN grinding discs		42
Electroplated diamond grinding points, cylindrical shape with radius end WR, grit size D357		26
Diamond grinding disc CC-GRIND-SOLID-DIAMOND		38
Grinding points for foundries		36
Diamond cut-off wheels, grit size D64/D151		34
Diamond cut-off wheels, grit size D357/D427		34
Diamond sabre saw blades		38
Diamond cut-off wheels, grit size D852		34



Diamond and CBN tools

Abrasives, materials, grit sizes

Super-hard abrasives

Diamond and CBN form the group of super-hard abrasives.

Diamond is the hardest naturally occurring solid. It consists of pure carbon in a crystalline structure. For grinding tools, the diamonds used are generally synthetic, produced at very high temperatures under high pressure. The properties of the abrasive can be optimized for the subsequent application of the tool.

CBN (cubic boron nitride) is the second-hardest solid known. It consists of boron and nitrogen in a crystalline structure.

For work on certain materials, diamond and CBN tools are an economic alternative to tools with conventional abrasives such as aluminium oxide and silicon carbide. Diamond and CBN grain is much harder and its cutting edges are very resistant to blunting. Diamond and CBN tools therefore enjoy a very long tool life.

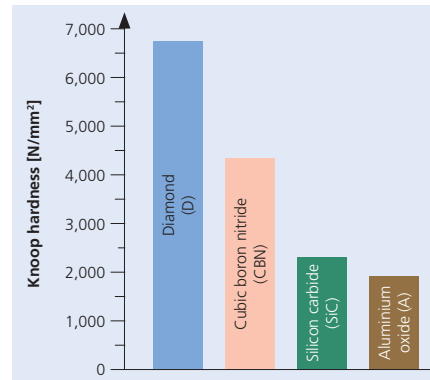

Materials

Diamond and CBN abrasives are used when materials cannot be machined with conventional abrasives such as aluminium oxide or silicon carbide. They also provide a more economical solution for many applications.

Due to high chemical wear, rotating diamond tools are not suitable for work on steel. CBN tools are used for these applications. The two abrasives complement each other ideally. In the adjacent overview, you will find various materials associated with the abrasives.

Using the colour coding system, the abrasive of the tool can be identified immediately.

Diamond = blue

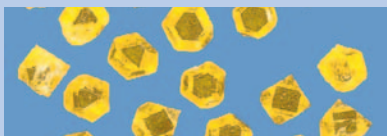

- Duroplastics, in particular with glass or carbon fibre reinforcement (GRP and CRP)
- Ferrite (magnetic material)
- Glass
- Graphite and synthetic carbon
- Grey and nodular cast iron
- Tungsten carbide
- Nickel- or titanium-based superalloys
- Technical ceramics
- Wear-resistant coatings (powder metal alloys and hardfacing alloys)

CBN = red







- Case-hardened steels
- Roller-bearing and ball-bearing steels
- Tool steels
- Other hardened steel materials with a hardness from approx. 54 HRC

Grit sizes

The grit size data for diamond and CBN tools relates to the average grit diameter in [µm]. Thus, the higher the number specified in the grit designation, the coarser the grit size. A coarse grit size increases stock removal and the surface roughness of the workpiece.

Selecting the optimum grit size depends on the intended application, the material to be machined, the tool drive employed and a wide range of other factors. As a general rule, the harder the material to be worked and the finer the desired surface roughness, the finer the selected grit size should be.

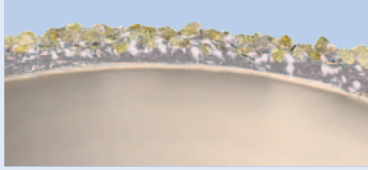
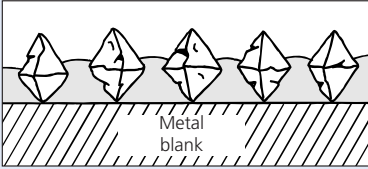
Grit sizes	Grit designations [µm] ISO 6106 (FEPA Standard)		Equivalent US mesh number/inch US Mesh Size
	Diamond	CBN	
Micro-grit	D 25 / D 30	-	-
	D 46	B 46	325/400
	D 54	B 54	270/325
	D 64	B 64	230/270
	D 76	B 76	200/230
	D 91	B 91	170/200
	D 107	B 107	140/170
	D 126	B 126	120/140
	D 151	B 151	100/120
	D 181	B 181	80/100
	D 213	B 213	70/80
	D 251	-	60/70
	-	B 252	60/80
	D 301	B 301	50/60
	D 357	B 357	45/50
	D 427	B 427	40/50
	D 502	-	35/45
	D 602	-	30/40
	D 711	-	25/30
	D 852	-	20/30
	D 1001	-	16/20

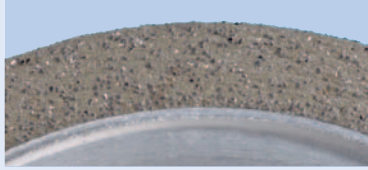
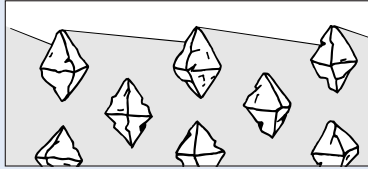
	Electroplated bond	Resinoid and metal bond
Bond type	  	  
Tool construction	<p>The main characteristic of electroplated tools is the monolayer coating with diamond or CBN grit. The coating is provided by the fixation of abrasive grit onto a metal blank via an electrochemically deposited nickel layer. The nickel layer thickness is around half of the grit diameter used.</p>	<p>The abrasive coating of resinoid-bonded diamond and CBN tools consists of abrasive grit, bond and fillers. The bond is tightly pressed, i.e. it has no pores.</p> <p>The metal bond is closely related to the resinoid bond. It is characterized by a higher grit retention strength and dimensional stability when compared to the resinoid bond.</p>
Advantages	<ul style="list-style-type: none"> ■ Shorter work time due to the coating type ■ Reduction in unproductive idle times because dressing and profiling are not required ■ Reduction in tool costs due to the monolayer coating and the possibility of recoating ■ Individual tool profiles ■ Constant tool geometry due to the monolayer coating <p>Further information on the advantages of electroplated grinding tools can be found on page 13.</p>	<p>Resinoid bond:</p> <ul style="list-style-type: none"> ■ The characteristics of the resinoid bond can be optimally adjusted to the application ■ Easy to dress <p>Metal bond:</p> <ul style="list-style-type: none"> ■ High dimensional stability and wear resistance
Applications	<p>Electroplated tools are problem solvers for work on various materials, such as particularly hard or abrasive materials. Among other things, the characteristics of the electrochemically coated tools can be adapted to the application through the selection of the grit sizes.</p> <p>Electroplated diamond and CBN tools are used for both wet and dry grinding.</p>	<p>Resinoid-bonded diamond and CBN grinding discs are often used for grinding, i.e. sharpening tungsten carbide or HSS tools, as well as in other production grinding processes.</p> <p>Metal-bonded tools are used for grinding glass and industrial ceramics.</p> <p>Resinoid and metal-bonded diamond and CBN tools are used for both wet and dry grinding, according to the tool specification.</p>
	Pages 12–38	Pages 39–47



Diamond and CBN tools

Recommended cutting speeds

The recommended cutting speed ranges depend on the application and must not exceed the maximum permissible peripheral speed. Because of the wide range of tasks and application fields of electroplated diamond and CBN tools, as well as the large influence of the employed tool drive, it is not possible to specify a generally valid cutting speed. The recommended cutting speed ranges serve as reference values.

Generally, the following applies:

- In dry grinding, do not use diamond tools at too high a cutting speed in order to avoid thermal damage to the abrasive.
- If possible, do not use CBN tools under the cutting speeds specified below. The optimum cutting speed has a direct effect on the economic value of the tools in use.
- All parameters must always be coordinated with each other within the grinding process. If the cutting speed is changed, among others the feed, infeed and coolant supply must be adjusted accordingly.
- Electroplated diamond and CBN tools can be used in dedicated stationary applications up to a peripheral speed of 125 m/s.

Cutting speed [m/s] ▶			5	10	15	20	25	30	35	40	45	...	80
Electroplated bond	Diamond	Dry grinding			8–18 m/s					30–80 m/s for CRP/GRP as well as grey and nodular cast iron			
		Wet grinding				15–25 m/s							
	CBN	Dry grinding				15–25 m/s							
		Wet grinding					20–40 m/s						
Resinoid bond	Diamond	Dry grinding			15–20 m/s								
		Wet grinding				20–30 m/s							
	CBN	Dry grinding				18–30 m/s							
		Wet grinding					25–40 m/s						
Metal bond	Diamond	Dry grinding		10–15 m/s									
		Wet grinding				15–30 m/s							
	CBN	Wet grinding					25–30 m/s						

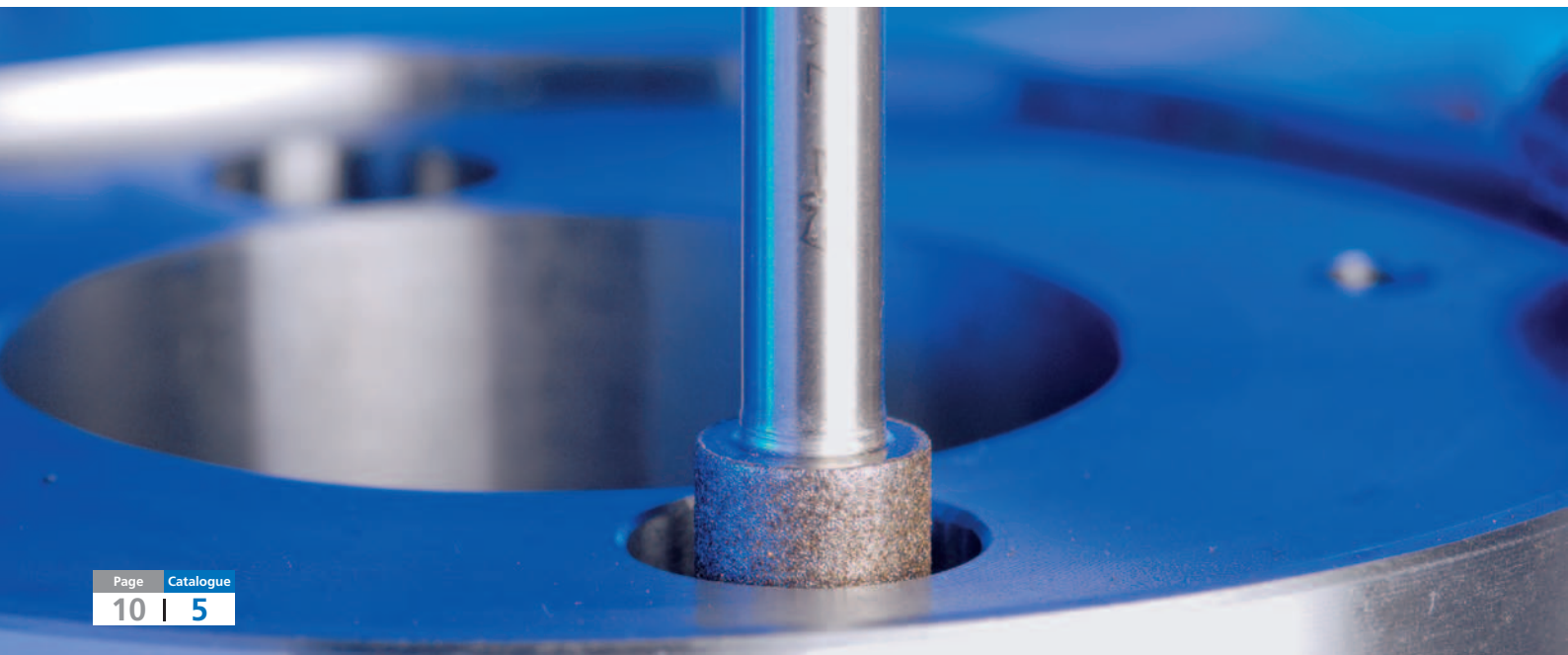

Refer to the table for the recommended rotational speed based on the diameter and cutting speed of your tool.

Example:
 Diamond grinding point
 Diameter: 20 mm
 Cutting speed: 25 m/s
Rotational speed rounded off: 23,900 RPM

Tool dia. [mm]	Cutting speed [m/s]											
	8	12	15	18	20	25	30	40	50	80	100	125
Rotational speed rounded off [RPM]												
1	153,000	-	-	-	-	-	-	-	-	-	-	-
2	76,400	115,000	143,000	172,000	191,000	-	-	-	-	-	-	-
3	50,900	76,400	95,500	115,000	127,000	159,000	191,000	-	-	-	-	-
4	38,200	57,300	71,600	85,900	95,500	119,000	143,000	-	-	-	-	-
5	30,600	45,800	57,300	68,800	76,400	95,500	115,000	153,000	-	-	-	-
6	25,500	38,200	47,700	57,300	63,700	79,600	95,500	127,000	159,000	-	-	-
7	21,800	32,700	40,900	49,100	54,600	68,200	81,900	109,000	136,000	-	-	-
8	19,100	28,600	35,800	43,000	47,700	59,700	71,600	95,500	119,000	191,000	-	-
9	17,000	25,500	31,800	38,200	42,400	53,100	63,700	84,900	106,000	170,000	-	-
10	15,300	22,900	28,600	34,400	38,200	47,700	57,300	76,400	95,500	153,000	191,000	-
12	12,700	19,100	23,900	28,600	31,800	39,800	47,700	63,700	79,600	127,000	159,000	199,000
14	10,900	16,400	20,500	24,600	27,300	34,100	40,900	54,600	68,200	109,000	136,000	171,000
15	10,200	15,300	19,100	22,900	25,500	31,800	38,200	50,900	63,700	102,000	127,000	159,000
16	9,500	14,300	17,900	21,500	23,900	29,800	35,800	47,700	59,700	95,500	119,000	149,000
18	8,500	12,700	15,900	19,100	21,200	26,500	31,800	42,400	53,100	84,900	106,000	133,000
20	7,600	11,500	14,300	17,200	19,100	23,900	28,600	38,200	47,700	76,400	95,500	119,000
22	6,900	10,400	13,000	15,600	17,400	21,700	26,000	34,700	43,400	69,400	86,800	109,000
25	6,100	9,200	11,500	13,800	15,300	19,100	22,900	30,600	38,200	61,100	76,400	95,500
30	5,100	7,600	9,500	11,500	12,700	15,900	19,100	25,500	31,800	50,900	63,700	79,600
40	3,800	5,700	7,200	8,600	9,500	11,900	14,300	19,100	23,900	38,200	47,700	59,700
50	3,100	4,600	5,700	6,900	7,600	9,500	11,500	15,300	19,100	30,600	38,200	47,700
75	2,000	3,100	3,800	4,600	5,100	6,400	7,600	10,200	12,700	20,400	25,500	31,800
100	1,530	2,300	2,900	3,400	3,800	4,800	5,700	7,600	9,500	15,300	19,100	23,900
125	1,220	1,830	2,300	2,800	3,100	3,800	4,600	6,100	7,600	12,200	15,300	19,100
150	1,020	1,530	1,910	2,300	2,500	3,200	3,800	5,100	6,400	10,200	12,700	15,900
175	870	1,310	1,640	1,960	2,200	2,700	3,300	4,400	5,500	8,700	10,900	13,600
200	760	1,150	1,430	1,720	1,910	2,400	2,900	3,800	4,800	7,600	9,500	11,900
230	660	1,000	1,250	1,490	1,660	2,100	2,500	3,300	4,200	6,600	8,300	10,400
250	610	920	1,150	1,380	1,530	1,910	2,300	3,100	3,800	6,100	7,600	9,500
300	510	760	950	1,150	1,270	1,590	1,910	2,500	3,200	5,100	6,400	8,000
350	440	650	820	980	1,090	1,360	1,640	2,200	2,700	4,400	5,500	6,800
400	380	570	720	860	950	1,190	1,430	1,910	2,400	3,800	4,800	6,000
450	340	510	640	760	850	1,060	1,270	1,700	2,100	3,400	4,200	5,300
500	310	460	570	690	760	950	1,150	1,530	1,910	3,100	3,800	4,800
600	250	380	480	570	640	800	950	1,270	1,590	2,500	3,200	4,000



Safety notes:

The operator is responsible for the grinding application, including correct tool drive use, correct handling and use of the grinding tools.



= Wear eye protection!



= Wear hearing protection!



= Read the safety instructions!



= Wear a dust mask!



= Wear gloves!



PFERD
D357

RPM max 20372
EN 13236

PFERD
D151

RPM max 30558
EN 13236

PFERD
D427

RPM max 6112
EN 13236

PFERD
D 427

The advantages of electroplated diamond and CBN grinding tools

Individual tool geometry

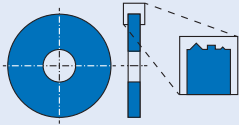

- Since virtually any machine-produced tool blank geometry can be used, electroplated diamond and CBN tools offer maximum flexibility in terms of tool profiles.

Shorter processing time

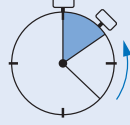

- The individual diamond or CBN grit projects well out of the electroplated bond. The resulting large chip spaces reduce tool loading while delivering very high stock removal. In conjunction with a sharp-edged super-hard grit, they guarantee maximum cutting characteristics and a very high stock removal rate.

Constant tool geometry



- The tool geometry of electroplated tools is retained thanks to the monolayer coating. This eliminates time-consuming profiling. The constant tool diameter enables work on deep-lying areas for a large number of workpieces, minimizes the formation of dust and allows use on robots.

Reduction in unproductive idle time

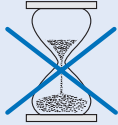

- The combination of the super-hard diamond or CBN abrasives and an electroplated bond results in a very long tool life and thus a reduction in tool changing times.
- No expensive and complicated dressing. Electroplated diamond and CBN tools are ready for immediate use thanks to their monolayer coating.

Reduction in tool costs

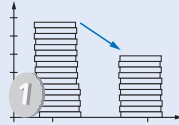

- Electroplated tools are less expensive than tools with other bond types due to their monolayer coating. They also provide an economic solution for the production of small batch sizes.
- Complex and/or large tool blanks can be recoated and reused.

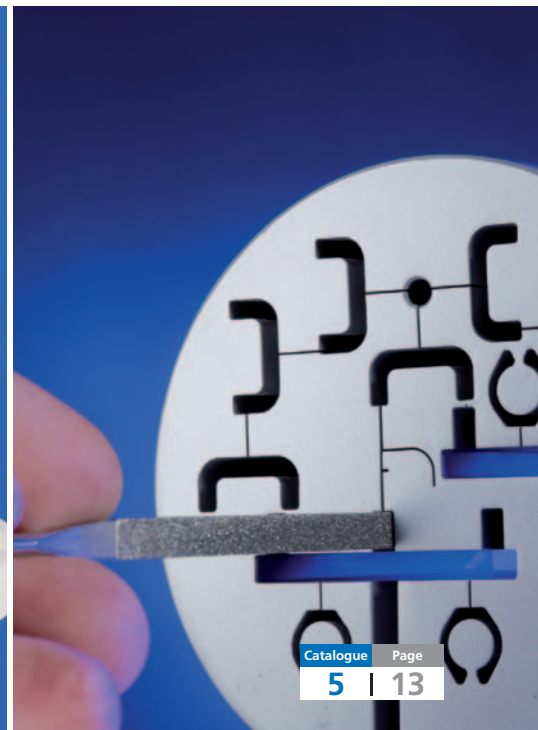
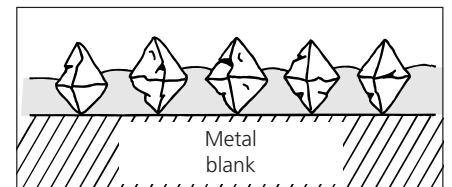
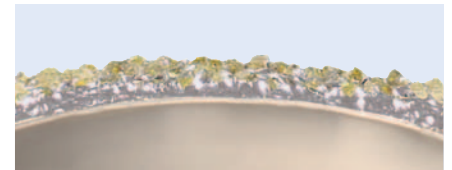

Diamond and CBN tools electroplated bond

Customer-specific tool solutions

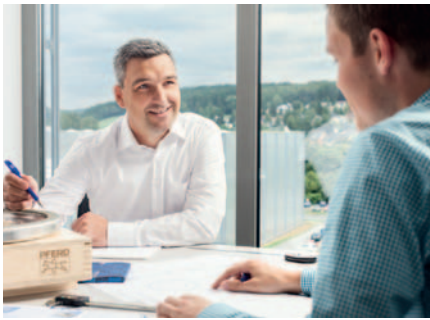

PFERD specializes in consultancy for and the production of customer-specific electroplated diamond and CBN tools.

Almost all tool blank geometries can be coated with various grit sizes. The electroplated bond also enables economic production of small batch sizes. Because of the diverse possibilities, our production can respond to individual customer requirements with a high degree of flexibility.

Our technical advisers will be happy to visit you on-site to develop individual tool solutions for your applications.

Get the best possible advice for super-hard solutions!

1. Process analysis and tool development

Contact us at www.pferd.com and arrange an appointment with our experienced sales representatives and technical advisers.

If you already have precise ideas about the desired tool, you can provide us with a technical drawing or a dimensioned sketch and information on the desired abrasives and grit sizes.

Our employees **will analyse your application with you on-site** and develop the most economic individual tool solution for you. You will then immediately receive a quote. Three production variants are possible:

2. Production

Complete production

From design and construction, through manufacture of the tool blank (steel, stainless steel or brass) and its coating with diamond or CBN grit, to the balancing of the finished tool, PFERD offers you all the production steps from a single source. This guarantees you the highest level of quality, flexibility and on-time delivery.

Coating

Steel, stainless steel or brass blanks provided by the customer can also be coated with diamond or CBN grit. Close cooperation at an early stage is recommended.

Recoating

PFERD offers recoating of blunt tools with steel or stainless steel blanks as an economic alternative to replacement production.

Tools with brass blanks cannot be recoated.

3. Use

Our flexible production and global logistics network ensure that you receive your new tool on time.

If desired, your personal sales representative and a technical adviser will set up all the process parameters together with you.

See the quality, performance and economic value of PFERD tools for yourself!

PFERD offers comprehensive information on various topics related to cutting and work on surfaces.

In our **PRAXIS brochure "PFERD tools for use on plastics"** you will find lots of information about plastics and their properties, valuable practical tips and tricks, as well as the appropriate tools which meet the high demands of this material.

Please contact us for further details!

In the brochure **"Electroplated diamond tools – economical processing of grey and nodular cast iron"** we have combined our standard and special product range for use on grey and nodular cast iron.



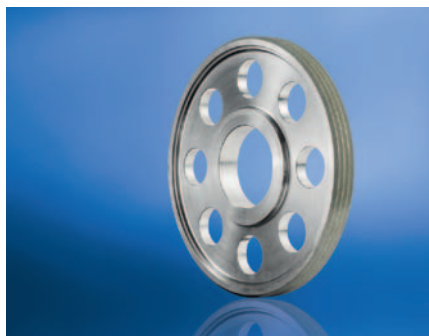
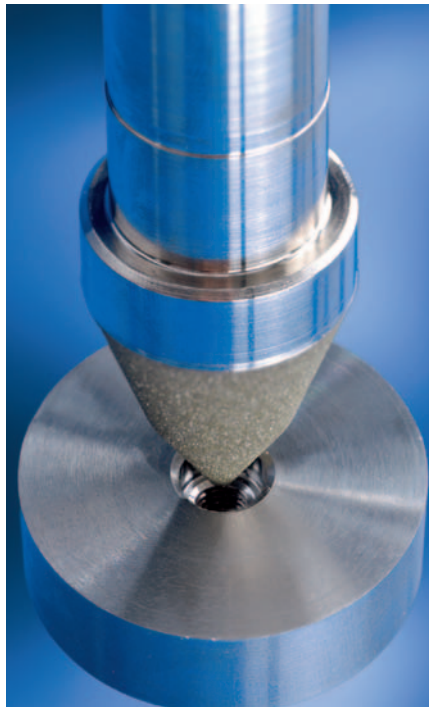
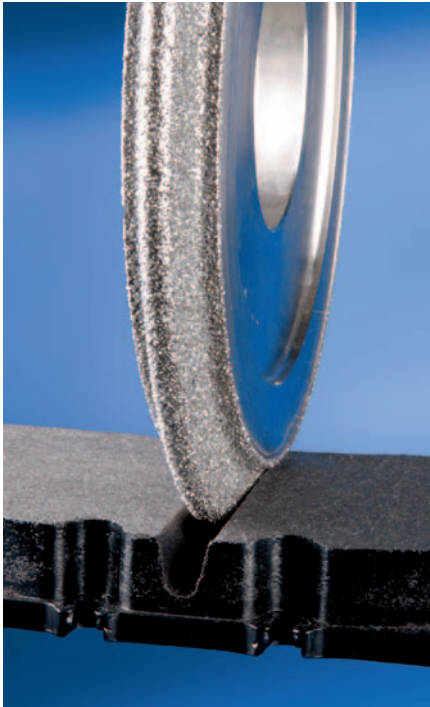

Diamond and CBN tools electroplated bond

Diamond files and sheets

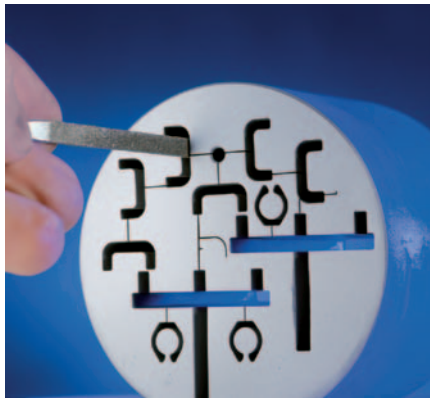

Diamond files and sheets are used particularly successfully for tasks where conventional files fail due to the hardness of the material to be worked.

Recommendations for use:

- Apply only slight pressure to the file, especially in workpiece edge areas.
- Loaded diamond files can be cleaned in kerosene or anti-static plastic cleaner with a file brush. Alternatively, ultrasonic cleaning is also possible. Often it will suffice to knock the file against a hard object.
- Avoid contact with grease when using files!

Note:

Diamond files and sheets are also used for processing hardened steel. The working temperatures are so low that no chemical wear occurs. This allows the higher hardness of the diamond grain to be exploited for a longer tool life.

Ordering notes:

- Please complete the description with the desired grit size.

Diamond escapement files



Diamond escapement files

Diamond escapement files are used on very small shapes in tool making and precision mechanics. They have a forged shank which allows use without an additional handle. Grit sizes D 25 and D 46 provide ultra-fine surface finishes.

PFERDVALUE:



Profile	Cross section with coating [mm]	Overall length [mm]	Coating length [mm]	Grit size				Description	
				D 25	D 46	D 91	D 126		
				EAN 4007220					
half-round	4.2 x 1.5	140	40	535530	323625	254622	254639	1	DF 3608 ...
crossing oval	3.8 x 1.8	140	40	535516	323632	254462	254479	1	DF 3609 ...
barrette	4 x 1.2	140	40	535509	323649	254493	254509	1	DF 3610 ...
three square	3	140	40	535561	323656	254554	254578	1	DF 3614 ...
hand	4 x 1.2	140	40	535578	323663	254523	254530	1	DF 3617 ...
square	2 x 2	140	40	535547	323670	254592	254608	1	DF 3619 ...
round	1.8	140	40	535523	323687	254653	254660	1	DF 3621 ...



Diamond escapement file sets

Diamond escapement file sets are supplied in a sturdy, practical plastic box which protects the tools from damage. This is ideal for keeping in the tool trolley or workbench.

Contents:

- 1 piece each:
- DF 3608 (half-round)
 - DF 3614 (three square)
 - DF 3617 (hand)
 - DF 3619 (square)
 - DF 3621 (round)

PFERDVALUE:



Grit size				Description
D 25	D 46	D 91	D 126	
EAN 4007220				
535639	323700	323694	017364	1
				DF 3090 ...

Diamond needle files

Diamond needle files are designed for general use in tool making.

Diamond needle files in extra slim design (S) are particularly suitable for work on deep-set and narrow contours.

Accessories:

- Quick-mounting handle SH 220 (EAN 4007220806555)
- Needle file holder NFH 212 (EAN 4007220669532)

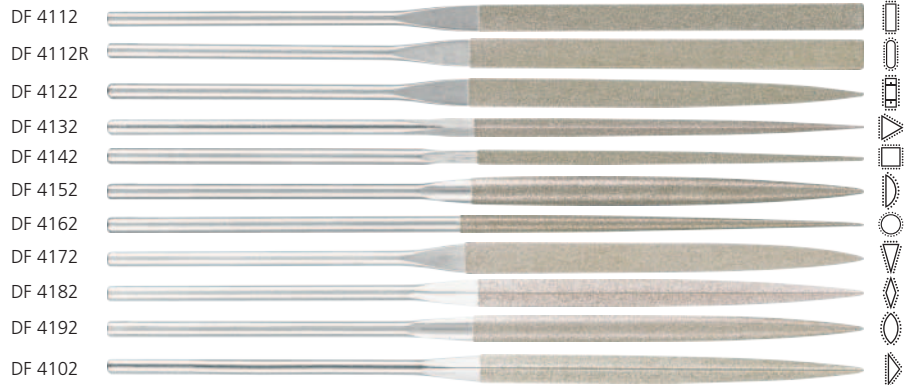

Profile	Cross section with coating [mm]	Overall length [mm]	Coating length [mm]	Grit size				Description
				D 91	D 126	D 181		

Needle files, extra slim (S)

EAN 4007220								
hand	5.3 x 1.3	140	70	-	806227	-	1	DF 4112S ...
three square	2.8	140	70	-	806258	-	1	DF 4132S ...
square	2.3	140	70	-	806289	-	1	DF 4142S ...
round	2.8	140	70	-	806319	-	1	DF 4162S ...

Needle files

hand	5.5 x 1.6	140	70	016664	016671	016688	1	DF 4112 ...
hand with rounded edges	5.5 x 1.6	140	70	016695	016701	016718	1	DF 4112R ...
flat	5.5 x 1.6	140	70	016725	016732	016749	1	DF 4122 ...
three square	3.5	140	70	016756	016763	016770	1	DF 4132 ...
square	2.6 x 2.6	140	70	016787	016794	016800	1	DF 4142 ...
half-round	5.5 x 1.6	140	70	016817	016824	016831	1	DF 4152 ...
round	3.2	140	70	016848	016855	016862	1	DF 4162 ...
knife	5 x 1.8	140	70	016879	016886	016893	1	DF 4172 ...
feather edge	5 x 2.4	140	70	016909	016916	-	1	DF 4182 ...
crossing oval	5 x 2.2	140	70	016930	016947	-	1	DF 4192 ...
barrette	5 x 2	140	70	016633	016640	-	1	DF 4102 ...

Diamond needle file sets

Diamond needle file sets are supplied in a sturdy, practical plastic box which protects the tools from damage. This is ideal for keeping in the tool trolley or workbench.

Contents DF 4205:

- 1 piece each:
- DF 4112 (hand)
 - DF 4132 (three square)
 - DF 4142 (square)
 - DF 4152 (half-round)
 - DF 4162 (round)

Contents DF 4211:

- 1 piece each:
- DF 4112 (hand)
 - DF 4112R (hand with rounded edges)
 - DF 4122 (flat)
 - DF 4132 (three square)
 - DF 4142 (square)
 - DF 4152 (half-round)
 - DF 4162 (round)
 - DF 4172 (knife)
 - DF 4182 (feather edge)
 - DF 4192 (crossing oval)
 - DF 4102 (barrette)



Grit size				Description
D 91	D 126	D 181		
EAN 4007220				
017371	017388	017395	1	DF 4205 ...
017401	017418	017425	1	DF 4211 ...



Diamond and CBN tools electroplated bond

Diamond riffler files



Diamond riffler files

Diamond riffler files are used for work in hard-to-reach areas and on complex geometries. The coating length is 25 mm on both sides of the files.

Accessories:

- Riffler file holder RFH 150 (EAN 4007220015322)



Profile	Cross section with coating [mm]	Overall length [mm]	Double-sided coating length [mm]	Grit size			Description
				D 91	D 126		
				EAN 4007220			
crossing oval	3.2 x 2	150	25	017029	017036	1	DF 15 ...
	3.7 x 2	150	25	017050	017067	1	DF 16 ...
hand	3.1 x 3	150	25	017081	017098	1	DF 18 ...
square	2.5 x 2.5	150	25	017111	017128	1	DF 20 ...
three square	3	150	25	017142	017159	1	DF 22 ...
round	3	150	25	017173	017180	1	DF 24 ...
hand	3.8 x 1.6	150	25	016961	016978	1	DF 914 ...
	4 x 2	150	25	016992	017005	1	DF 918 ...



Diamond riffler file set

The diamond riffler file set is supplied in a sturdy, practical plastic box which protects the tools from damage. This is ideal for keeping in the tool trolley or workbench.

Contents:

- 1 piece each:
 - DF 16 (crossing oval)
 - DF 18 (hand)
 - DF 20 (square)
 - DF 22 (three square)
 - DF 24 (round)

Grit size		Description
D 126		
EAN 4007220		
355381		
	1	DF 1624 D 126

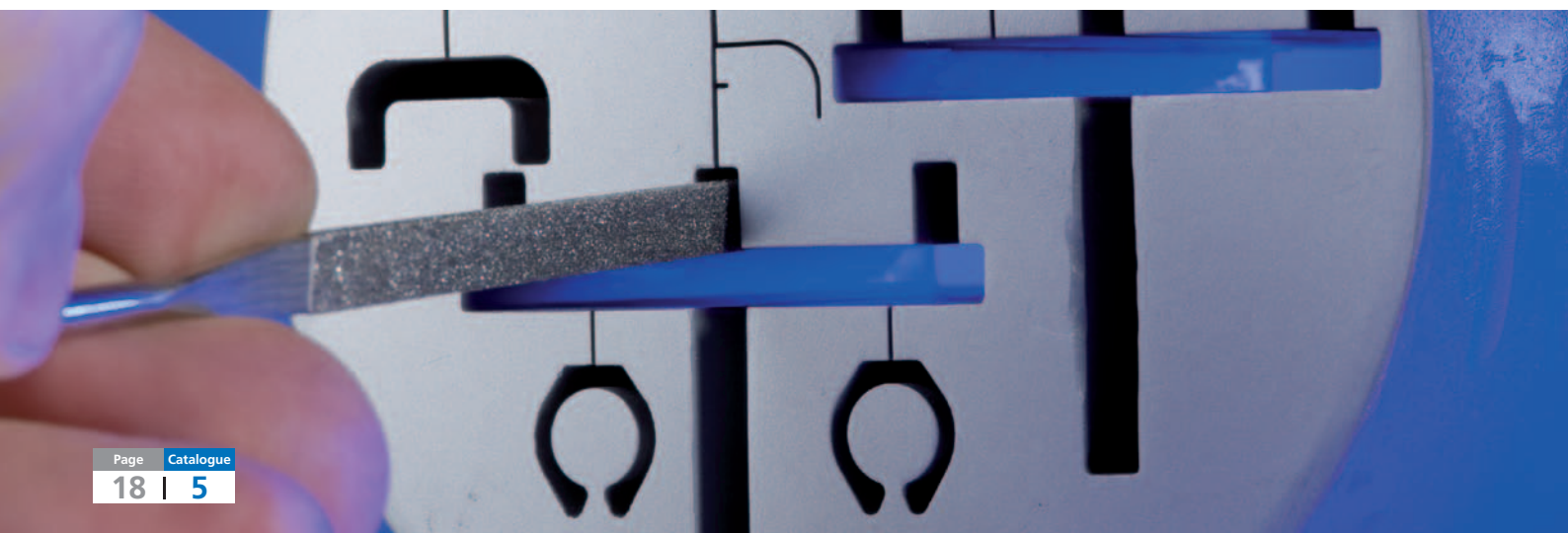

Diamond handy files

Diamond handy files have a forged shank which allows the use without an additional handle.

PFERDVALUE:



Profile	Cross section with coating [mm]	Overall length [mm]	Coating length [mm]	Grit size		Description
				D 126	D 181	
				EAN 4007220		
hand	10.3 x 2.8	215	100	017302	535455	1 DF 2601 ...
half-round	12.5 x 3.8	215	100	017319	535462	1 DF 2602 ...
three square	10	215	100	017326	535479	1 DF 2607 ...
square	5.5 x 5.5	215	100	017333	535486	1 DF 2608 ...
round	6.7	215	100	017340	535493	1 DF 2610 ...

Diamond handy file sets

Diamond handy file sets are supplied in a sturdy, practical plastic box which protects the tools from damage. This is ideal for keeping in the tool trolley or workbench.

Contents:

- 1 piece each:
- DF 2601 (hand)
- DF 2602 (half-round)
- DF 2607 (three square)
- DF 2608 (square)
- DF 2610 (round)

PFERDVALUE:



Grit size		Description
D 126	D 181	
EAN 4007220		
017357	535585	1 DF 2627 ...

Conical diamond files

Conical diamond files

The conical diamond files are used on particularly narrow, deep contours in toolmaking. Because of the forged shank, they can be used without a handle.



Width A [mm]	Thickness B [mm]	Thickness B ₁ [mm]	Overall length [mm]	Coating length [mm]	Grit size			Description
					D 46	D 91	D 126	
					EAN 4007220			
4.0	2.0	0.5	170	50	070635	070659	070666	1 DF-K 170-4-2-0,5 ...
6.0	2.4	0.5	170	50	070673	070680	070697	1 DF-K 170-6-2,4-0,5 ...
8.0	2.4	0.5	170	50	070703	070710	070727	1 DF-K 170-8-2,4-0,5 ...
10.0	2.5	0.5	170	50	070734	070741	070758	1 DF-K 170-10-2,5-0,5 ...

Diamond and CBN tools electroplated bond

Diamond machinist's files



Diamond machinist's files

Diamond machinist's files are used, among other industries, in large tool construction. Grit size D 251 is also suitable for work on fibre-reinforced plastics (GRP/CRP).

Diamond machinist's files are supplied with an ergonomic handle.

PFERDVALUE:



Profile	Cross section with coating [mm]	Overall length [mm]	Coating length [mm]	Grit size				Description
				D 126	D 151	D 251		
				EAN 4007220				
hand	10 x 3.2	100	85	255117	805954	805961	1	DF 1112/100 ...
	11.2 x 4.2	125	110	255131	955888	-	1	DF 1112/125 ...
	13 x 5	150	135	255155	805978	805985	1	DF 1112/150 ...
	22.5 x 5.5	200	180	-	017203	017210	1	DF 1112/200 ...
three square	7	100	85	255179	955895	-	1	DF 1132/100 ...
	14	200	180	-	017227	017234	1	DF 1132/200 ...
square	7.5 x 7.5	200	180	-	017241	-	1	DF 1142/200 ...
half-round pointed	12 x 4	100	85	255193	955901	-	1	DF 1152/100 ...
	22 x 6.5	200	180	-	017265	017272	1	DF 1152/200 ...
round	8	200	180	-	017289	-	1	DF 1162/200 ...



Flexible diamond files

The flexible diamond files perfectly adapt to the workpiece surface. Due to its flexibility, they can be used in convex and concave contours with small radii.

Recommendations for use:

- Only use files up to a bending radius of 15 mm.



Cross section with coating [mm]	Overall length [mm]	Coating type	Grit size				Description
			D 76	D 126	D 181		
			EAN 4007220				
0.5 x 14	165	one side	004920	004951	004968	5	DF-FLEX 14-165 ...

Diamond sheets

Diamond sheets

The diamond sheets are exceptionally well suited to work on larger surfaces. Convex and concave contours can be worked on with relatively little effort.



Cross section with coating [mm]	Overall length [mm]	Coating type	Grit size			Description
			D 64	D 126		
			EAN 4007220			
0.7 x 30	170	complete	806371	955925	1	DBL 30-0,7-170 ...
1.3 x 35	350	complete	955918	806388	1	DBL 35-1,3-350 ...



Diamond and CBN tools electroplated bond

Diamond files for manual filing machines



Diamond files for manual filing machines

Diamond files for manual filing tools are suitable for use in machines, as well as for hand filing.

The shank diameter of the diamond files is 3 mm.

Accessories:

■ Air-powered filing machine PFGA 07/220 (EAN 4007220**657638**): For detailed information and ordering data, please refer to catalogue section 9.



Profile	Cross section with coating [mm]	Overall length [mm]	Coating length [mm]	Coating type	Grit size		Description
					D 126		
					EAN 4007220		
hand	2 x 1	50	15	one side	256718	1	DF 5301 D 126
	3 x 1	50	15	one side	256749	1	DF 5303 D 126
	4 x 1	50	15	one side	256817	1	DF 5305 D 126
	5 x 2	50	15	one side	256848	1	DF 5307 D 126
	5 x 2	60	25	one side	256879	1	DF 5309 D 126
	2 x 1	50	15	both sides	256909	1	DF 5310 D 126
	3 x 1	50	15	both sides	256930	1	DF 5311 D 126
	4 x 1	50	15	both sides	256961	1	DF 5312 D 126
	5 x 2	50	15	both sides	256992	1	DF 5313 D 126
	5 x 2	60	25	both sides	257029	1	DF 5314 D 126
square	0.5 x 4	50	15	face side	257050	1	DF 5316 D 126
	1.5 x 1.5	50	15	complete	257296	1	DF 5390 D 126
	3 x 3	50	15	complete	257326	1	DF 5391 D 126
round	4 x 4	50	15	complete	257357	1	DF 5392 D 126
	1	50	15	complete	257418	1	DF 5331 D 126
	2	50	15	complete	257449	1	DF 5335 D 126
	3	50	15	complete	257470	1	DF 5339 D 126
	4	50	15	complete	257500	1	DF 5345 D 126
	2	60	25	complete	257531	1	DF 5337 D 126
	3	60	25	complete	257562	1	DF 5343 D 126
three square	4	60	25	complete	257593	1	DF 5347 D 126
	2	50	15	complete	257173	1	DF 5365 D 126
	3.5	50	15	complete	257203	1	DF 5367 D 126
	3.5	60	25	complete	257234	1	DF 5371 D 126
crossing oval	4.5	60	25	complete	257265	1	DF 5375 D 126
	2 x 1	50	15	complete	257623	1	DF 5352 D 126
	3.5 x 2	50	15	complete	257654	1	DF 5356 D 126
	6 x 3	50	12	complete	257685	1	DF 5360 D 126
	3.5 x 2	60	25	complete	257715	1	DF 5358 D 126
knife	6 x 3	60	25	complete	257746	1	DF 5362 D 126
	1 x 4	50	15	complete	257777	1	DF 5380 D 126
	2 x 6	50	15	complete	257807	1	DF 5382 D 126
flat conical	3.3 x 1	55	16	complete	665862	1	DF 0103 D 126
	6.3 x 1	55	16	complete	665879	1	DF 0106/55 D 126
	6.3 x 1	73	16	complete	665886	1	DF 0106/73 D 126

Powered tools

Matching tool drives:

- Machine tool
- Robot
- Straight grinder
- Flexible shaft drive

Conditions for use:

- Because of the monolayer coating, drive spindles and tool holders must have a high concentricity. The finer the grit size used, the more accurate the concentricity needs to be.
- The tool drive must have sufficient drive output on the grinding spindle to ensure the required rotational speed, even under load.
- For stationary tool drives, the tool machine, tool and workpiece holder must be sufficiently rigid.
- The workpiece must be mounted stable.

Recommendations for use:

- Electroplated diamond and CBN tools can be used for both dry and wet grinding. If possible, wet grinding is to be preferred in order to reduce tool wear and the risk of thermal damage.
- Generally, the following applies: For optimum profitability, select a grit size that is as coarse as possible and as fine as necessary. Influencing factors include the hardness of the material and the surface quality required.
- Loaded tools can be cleaned using ultrasound. In the event of strong contamination on the coating, please clean using the sharpening block DSB 2005025 (EAN 4007220168332). More detailed information and ordering data can be found on page 52.
- Select as large a tool diameter as possible, since this increases the number of diamond or CBN grit that engage the workpiece. For internal grinding, the maximum tool diameter is 3/4 of the diameter to be ground.
- The longitudinal feed rate for internal grinding must not exceed 2/3 of the total width per workpiece rotation. The infeed depends on the material to be machined, the cutting speed, the stability of the tool, its holder and the tool drive.

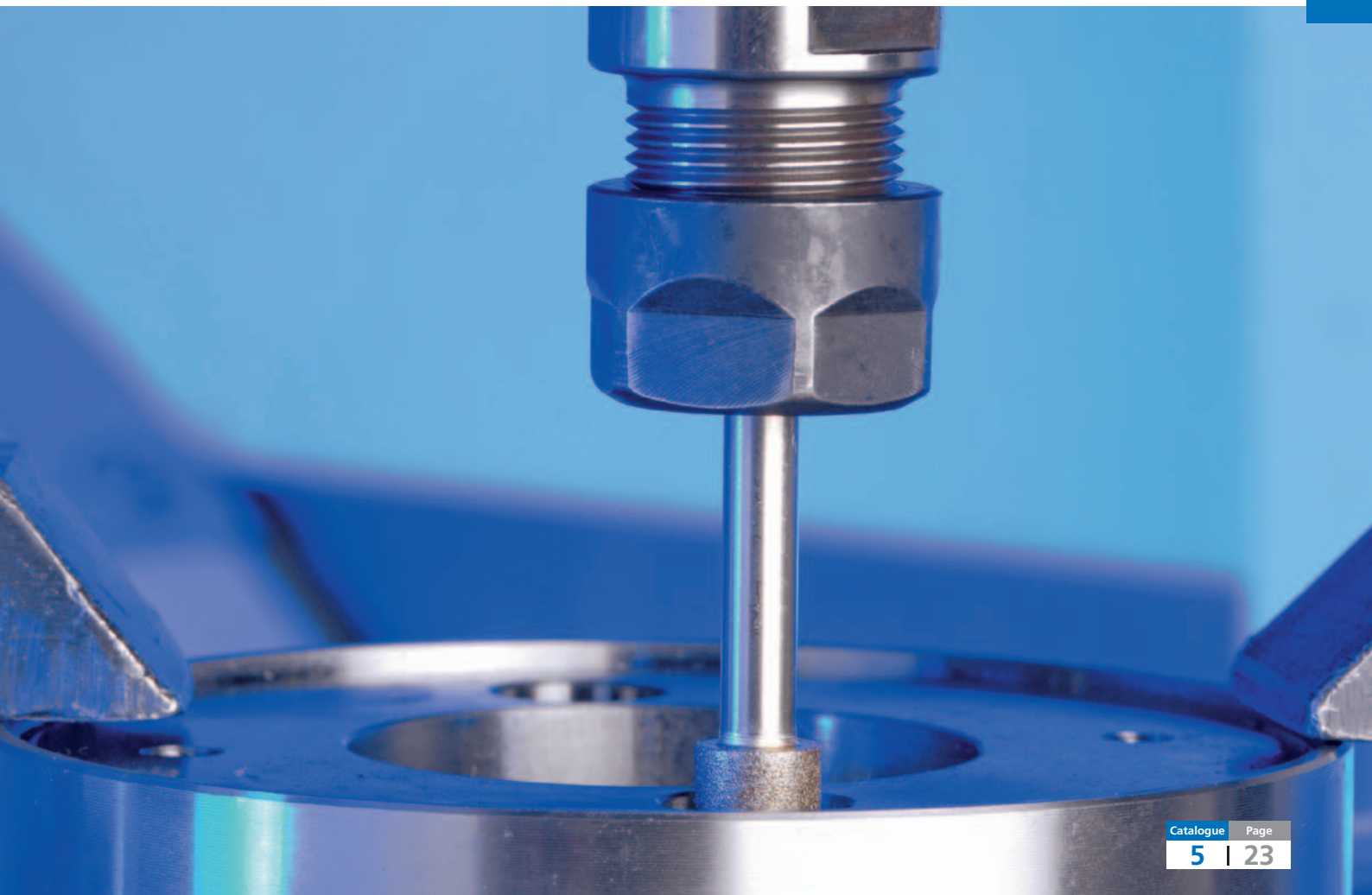

Diamond and CBN tools electroplated bond

Diamond grinding points

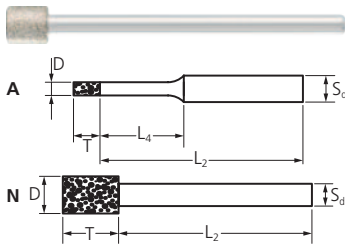

Cylindrical shape ZY

The cylindrical shape ZY is suitable for grinding bores, radii and contours using stationary or handheld equipment. Grinding points with a diameter of 8 mm or more have a recess on the front surface.

A = stepped shank
N = non-stepped shank

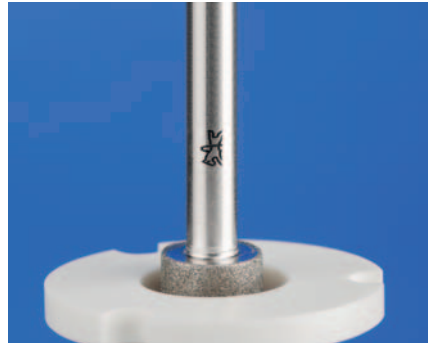

Recommendations for use:

- Dry grinding: 8–18 m/s
- Wet grinding: 15–25 m/s

Ordering notes:

- Please complete the description with the desired grit size.

PFERDVALUE:



D x T [mm]	S _d [mm]	L ₂ [mm]	L ₄ [mm]	Grit size				Description
				D 64	D 91	D 126	D 181	
				EAN 4007220				

Shank dia. 3 mm

0.5 x 2	3	38	5	354322	-	-	-	5	DZY-A 0,5-2/3 ...
0.8 x 2	3	38	5	354339	-	-	-	5	DZY-A 0,8-2/3 ...
1.0 x 4	3	36	9	354346	257883	257890	-	5	DZY-A 1,0-4/3 ...
1.2 x 4	3	36	9	354353	354360	354377	-	5	DZY-A 1,2-4/3 ...
1.4 x 4	3	36	9	354384	354391	354407	-	5	DZY-A 1,4-4/3 ...
1.6 x 4	3	36	10	-	354421	354438	-	5	DZY-A 1,6-4/3 ...
1.8 x 4	3	36	10	-	354452	354469	-	5	DZY-A 1,8-4/3 ...
2.0 x 4	3	36	10	354476	260784	119181	-	5	DZY-A 2,0-4/3 ...
2.2 x 4	3	36	14	-	354490	354506	-	5	DZY-A 2,2-4/3 ...
2.4 x 4	3	36	14	-	354520	354537	-	5	DZY-A 2,4-4/3 ...
2.6 x 4	3	36	14	-	354551	354568	-	5	DZY-A 2,6-4/3 ...
2.8 x 4	3	36	14	-	354582	354599	-	5	DZY-A 2,8-4/3 ...
3.0 x 4	3	36	19	354605	260821	119204	-	5	DZY-A 3,0-4/3 ...
3.5 x 5	3	45	-	-	260845	119211	-	5	DZY-N 3,5-5/3 ...
4.0 x 5	3	45	-	-	260869	119228	260876	5	DZY-N 4,0-5/3 ...
4.5 x 5	3	45	-	-	260883	119235	-	5	DZY-N 4,5-5/3 ...
5.0 x 5	3	45	-	-	260906	119242	260913	5	DZY-N 5,0-5/3 ...
5.5 x 6	3	44	-	-	257944	257951	257968	5	DZY-N 5,5-6/3 ...

Shank dia. 6 mm

6.0 x 6	6	54	19	-	260920	119259	260937	1	DZY-A 6,0-6/6 ...
7.0 x 8	6	52	-	-	-	119266	-	1	DZY-N 7,0-8/6 ...
8.0 x 8	6	52	-	-	260968	119273	260975	1	DZY-N 8,0-8/6 ...
9.0 x 8	6	52	-	-	-	258040	-	1	DZY-N 9,0-8/6 ...
10.0 x 8	6	52	-	-	260982	119280	260999	1	DZY-N 10,0-8/6 ...
12.0 x 8	6	52	-	-	261002	119297	261019	1	DZY-N 12,0-8/6 ...
15.0 x 10	6	50	-	-	-	119303	-	1	DZY-N 15,0-10/6 ...
18.0 x 10	6	50	-	-	-	258163	-	1	DZY-N 18,0-10/6 ...
20.0 x 10	6	50	-	-	-	258194	-	1	DZY-N 20,0-10/6 ...

Shank dia. 10 mm

15.0 x 10	10	110	-	-	-	355091	-	1	DZY-N 15,0-10/10 ...
-----------	----	-----	---	---	---	--------	---	---	----------------------

Shank dia. 12 mm

25.0 x 10	12	110	-	-	-	355138	-	1	DZY-N 25,0-10/12 ...
-----------	----	-----	---	---	---	--------	---	---	----------------------

Special shape ZY

The special shape ZY is suitable for grinding slits and grooves in hard-to-reach areas.

Recommendations for use:

- Dry grinding: 8–18 m/s
- Wet grinding: 15–25 m/s

Ordering notes:

- Please complete the description with the desired grit size.

PFERDVALUE:

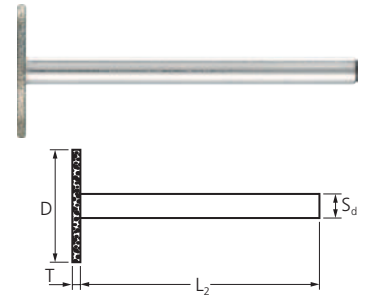

D x T [mm]	S _d [mm]	L ₂ [mm]	Grit size		Description
			D 64	D 91	
			EAN 4007220		

Shank dia. 3 mm

8.0 x 0.5	3	35	353240	-	1	DZY-N 8,0-0,5/3 ...
14.0 x 0.5	3	35	353257	-	1	DZY-N 14,0-0,5/3 ...
14.0 x 1	3	35	353264	353271	1	DZY-N 14,0-1,0/3 ...

Spherical shape KU

The spherical shape KU is often used in manual applications. This shape is well suited for engraving, contour grinding and deburring tasks.

A = stepped shank

N = non-stepped shank

Recommendations for use:

- Dry grinding: 8–18 m/s
- Wet grinding: 15–25 m/s

Ordering notes:

- Please complete the description with the desired grit size.

PFERDVALUE:

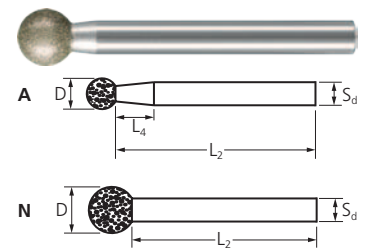

D [mm]	S _d [mm]	L ₂ [mm]	L ₄ [mm]	Grit size				Description
				D 64	D 91	D 126	D 181	
				EAN 4007220				

Shank dia. 3 mm

1.0	3	44	10	354926	258620	258637	258644	5	DKU-A 1,0/3 ...
2.0	3	43	8	354933	258651	258668	258675	5	DKU-A 2,0/3 ...
3.0	3	42	6	354940	258682	258699	258705	5	DKU-A 3,0/3 ...
4.0	3	41	5	-	258712	258729	258736	5	DKU-A 4,0/3 ...
5.0	3	40	2	-	258743	258750	258767	5	DKU-A 5,0/3 ...
6.0	3	39	-	-	258774	258781	258798	1	DKU-N 6,0/3 ...

Shank dia. 6 mm

8.0	6	52	10	-	-	258842	-	1	DKU-A 8,0/6 ...
10.0	6	50	5	-	-	258903	-	1	DKU-A 10,0/6 ...
12.0	6	48	-	-	-	258965	-	1	DKU-N 12,0/6 ...



Diamond and CBN tools electroplated bond

Diamond grinding points

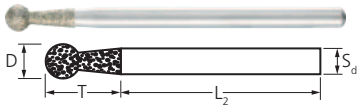

Special shape KU

The special shape KU is often used for deburring plastic profiles in manual applications. This shape is also coated with grit under the ball-shaped part of the grinding point on the stepped shank. The special shape of the tool provides optimum results when machining profiles.

Recommendations for use:

- Dry grinding: 8–18 m/s
- Wet grinding: 15–25 m/s

PFERDVALUE:



D x T [mm]	S _d [mm]	L ₂ [mm]	Grit size		Description
			D 181	EAN 4007220	

Shank dia. 3 mm

3.0 x 10	3	40	353844	1	DKU 3,0-10/3 D 181
4.0 x 10	3	40	353868	1	DKU 4,0-10/3 D 181

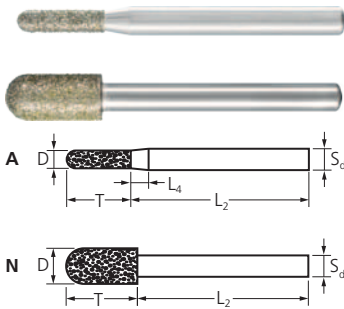

Cylindrical shape with radius end WR

The cylindrical shape with radius end WR is best suited to manual applications and can be used for a wide variety of deburring and grinding tasks. Coarse grit size D 357 is especially well suited to use on fibre-reinforced plastics (GRP/CRP).

A = stepped shank
N = non-stepped shank

Recommendations for use:

- Dry grinding: 8–18 m/s
- Wet grinding: 15–25 m/s

PFERDVALUE:



Ordering notes:

- Please complete the description with the desired grit size.

D x T [mm]	S _d [mm]	L ₂ [mm]	L ₄ [mm]	Grit size		Description
				D 126	D 357	

Shank dia. 6 mm

5.0 x 18	6	50	5	955932	353981	1	DWR-A 5,0-18/6 ...
6.0 x 18	6	50	5	955949	353998	1	DWR-A 6,0-18/6 ...
10.0 x 20	6	50	-	955956	354001	1	DWR-N 10,0-20/6 ...



More PFERD tools and tricks for work on plastics can be found in our PRAXIS brochure "PFERD tools for use on plastics". Please contact us.



Pointed tree shape SPG

The pointed tree shape SPG is exceptionally well suited to machining small holes or bores as well as for engraving work.

Recommendations for use:

- Dry grinding: 8–18 m/s
- Wet grinding: 15–25 m/s

PFERDVALUE:

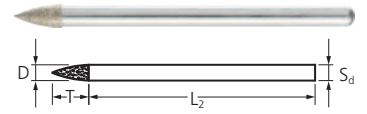

D x T [mm]	S _d [mm]	L ₂ [mm]	Grit size			Description
			D 126	EAN 4007220		
Shank dia. 3 mm						
3.0 x 7	3	43	536421		1	DSPG 3,0-7/3 D 126
3.0 x 13	3	37	806203		1	DSPG 3,0-13/3 D 126
Shank dia. 6 mm						
6.0 x 18	6	50	955963		1	DSPG 6,0-18/6 D 126

Cup shape KT

The cup shape KT is ideal for work on profiles, planar surfaces and ledges, without the cylindrical surface being damaged.

Recommendations for use:

- Dry grinding: 8–18 m/s
- Wet grinding: 15–25 m/s

PFERDVALUE:

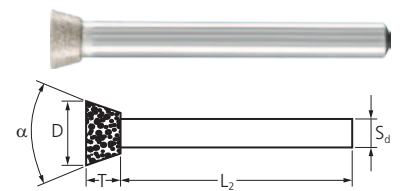

D x T [mm]	α	S _d [mm]	L ₂ [mm]	Grit size			Description
				D 126	EAN 4007220		
Shank dia. 3 mm							
3.0 x 7	8°	3	43	354018		1	DKT 3,0-8°/3 D 126
Shank dia. 6 mm							
10.0 x 5	30°	6	50	354025		1	DKT 10,0-30°/6 D 126



Diamond and CBN tools electroplated bond

Diamond grinding points

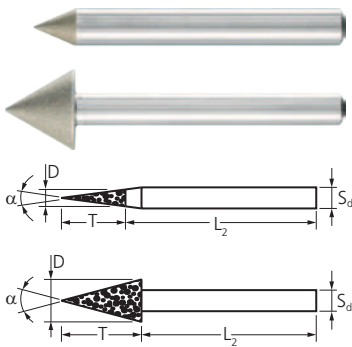

Conical pointed shape SK

The conical pointed shape SK is exceptionally well suited to deburring bores, regrinding centring holes and chamfering.



Recommendations for use:

- Dry grinding: 8–18 m/s
- Wet grinding: 15–25 m/s

Ordering notes:

- Please complete the description with the desired grit size.

PFERDVALUE:



D x T [mm]	α	S _d [mm]	L ₂ [mm]	Grit size			Description
				D 64	D 126		
				EAN 4007220			
Shank dia. 6 mm							
6.0 x 45	7°	6	50	354049	955970	1	DSK 6,0-7°/6 ...
6.0 x 26	12°	6	50	354056	955987	1	DSK 6,0-12°/6 ...
6.0 x 21	15°	6	50	354063	955994	1	DSK 6,0-15°/6 ...
6.0 x 11	30°	6	50	354032	354070	1	DSK 6,0-30°/6 ...
6.0 x 5	60°	6	50	393390	956007	1	DSK 6,0-60°/6 ...
10.0 x 9	60°	6	50	806128	806135	1	DSK 10,0-60°/6 ...
10.0 x 5	90°	6	50	806142	806159	1	DSK 10,0-90°/6 ...
15.0 x 13	60°	6	50	806166	806173	1	DSK 15,0-60°/6 ...
15.0 x 7.5	90°	6	50	806180	806197	1	DSK 15,0-90°/6 ...



Diamond grinding point set

The set contains 10 diamond grinding points with grit size D 126 in the most common shapes and dimensions. The sturdy plastic box protects the tools from dirt and damage.

Contents:

- 1 piece each:
 - DZY-A 1,0-4/3 D126
 - DZY-A 2,0-4/3 D126
 - DZY-N 4,0-5/3 D126
 - DZY-N 5,0-5/3 D126
 - DZY-N 14,0-1,1/3 D126
 - DKU-A 2,0/3 D126
 - DKU-A 4,0/3 D126
 - DKU-N 6,0/3 D126
 - DSPG 3,0-7,0/3 D126
 - DKT 3,0-8G/3 D126

Recommendations for use:

- Dry grinding: 8–18 m/s
- Wet grinding: 15–25 m/s

PFERDVALUE:

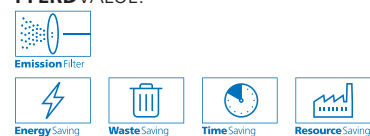

S _d [mm]	Grit size			Description
	D 126			
	EAN 4007220			
3	103845		1	D-Set/3 D126

Grinding discs 1A1

Diamond grinding discs are intended for use on stationary machines. Grinding discs with an outer diameter of 18 mm or more have an additional centring shoulder which allows them to be accurately mounted and aligned on the machine spindle. Combined with a stable mandrel, these tools are ideal for work in deep-set or long bores.

Recommendations for use:

- Dry grinding: 8–18 m/s
- Wet grinding: 15–25 m/s

PFERDVALUE:

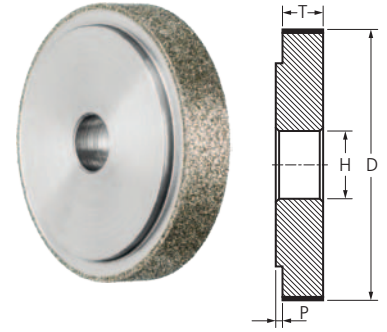

D x T [mm]	H [mm]	P [mm]	Grit size			Description
			D 151			
			EAN 4007220			
12.0 x 10	8	-	665893		1	D1A1 12-10-8 D 151
14.0 x 10	8	-	665961		1	D1A1 14-10-8 D 151
16.0 x 10	8	-	665978		1	D1A1 16-10-8 D 151
18.0 x 10	8	2	665992		1	D1A1 18-10-8 D 151
20.0 x 10	8	2	354629		1	D1A1 20-10-8 D 151
30.0 x 10	10	2	354636		1	D1A1 30-10-10 D 151
40.0 x 10	10	2	354643		1	D1A1 40-10-10 D 151
50.0 x 10	10	2	354131		1	D1A1 50-10-10 D 151



Diamond and CBN tools electroplated bond

CBN grinding points

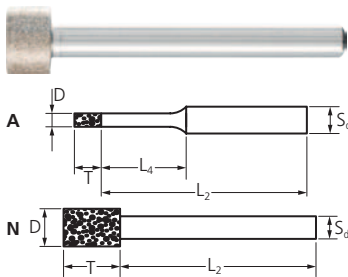

Cylindrical shape ZY

The cylindrical shape ZY is suitable for grinding bores, radii and contours using stationary or handheld equipment. Grinding points with a diameter of 8 mm or more have a recess on the front surface.

A = stepped shank
N = non-stepped shank

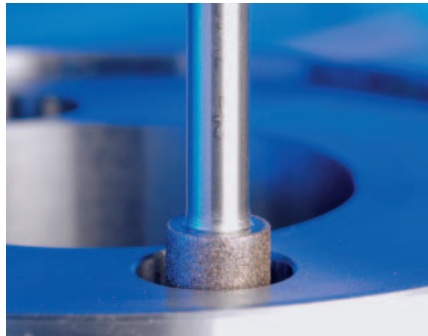

Recommendations for use:

- Dry grinding: 15–25 m/s
- Wet grinding: 20–40 m/s

Ordering notes:

- Please complete the description with the desired grit size.

PFERDVALUE:



D x T [mm]	S _d [mm]	L ₂ [mm]	L ₄ [mm]	Grit size			Description
				B 64	B 126		
				EAN 4007220			
Shank dia. 3 mm							
0.5 x 2	3	38	5	354650	-	5	BZY-A 0,5-2/3 ...
0.8 x 2	3	38	5	354667	-	5	BZY-A 0,8-2/3 ...
1.0 x 4	3	36	9	354674	258224	5	BZY-A 1,0-4/3 ...
1.2 x 4	3	36	9	354681	354698	5	BZY-A 1,2-4/3 ...
1.4 x 4	3	36	9	-	354711	5	BZY-A 1,4-4/3 ...
1.6 x 4	3	36	10	354728	354735	5	BZY-A 1,6-4/3 ...
1.8 x 4	3	36	10	-	354759	5	BZY-A 1,8-4/3 ...
2.0 x 4	3	36	10	354766	119310	5	BZY-A 2,0-4/3 ...
2.2 x 4	3	36	14	-	354780	5	BZY-A 2,2-4/3 ...
2.4 x 4	3	36	14	354797	354803	5	BZY-A 2,4-4/3 ...
2.6 x 4	3	36	14	354810	354827	5	BZY-A 2,6-4/3 ...
2.8 x 4	3	36	14	-	354841	5	BZY-A 2,8-4/3 ...
3.0 x 4	3	36	19	354858	119334	5	BZY-A 3,0-4/3 ...
3.5 x 5	3	45	-	354865	119341	5	BZY-N 3,5-5/3 ...
4.0 x 5	3	45	-	354872	119358	5	BZY-N 4,0-5/3 ...
4.5 x 5	3	45	-	-	119365	5	BZY-N 4,5-5/3 ...
5.0 x 5	3	45	-	354896	119372	5	BZY-N 5,0-5/3 ...
5.5 x 6	3	44	-	-	258286	5	BZY-N 5,5-6/3 ...
Shank dia. 6 mm							
6.0 x 6	6	54	19	354919	119389	1	BZY-A 6,0-6/6 ...
7.0 x 8	6	52	-	-	119396	1	BZY-N 7,0-8/6 ...
8.0 x 8	6	52	-	-	119402	1	BZY-N 8,0-8/6 ...
9.0 x 8	6	52	-	-	258408	1	BZY-N 9,0-8/6 ...
10.0 x 8	6	52	-	-	119419	1	BZY-N 10,0-8/6 ...
12.0 x 8	6	52	-	-	119426	1	BZY-N 12,0-8/6 ...
13.0 x 10	6	50	-	-	258460	1	BZY-N 13,0-10/6 ...
14.0 x 10	6	50	-	-	258491	1	BZY-N 14,0-10/6 ...
15.0 x 10	6	50	-	-	119433	1	BZY-N 15,0-10/6 ...
18.0 x 10	6	50	-	-	258521	1	BZY-N 18,0-10/6 ...
20.0 x 10	6	50	-	-	258552	1	BZY-N 20,0-10/6 ...
Shank dia. 10 mm							
15.0 x 10	10	110	-	-	355145	1	BZY-N 15,0-10/10 ...

Cylindrical points with carbide shank

Cylindrical points with tungsten carbide shank are used for internal grinding on stationary machines.

The elastic modulus of the tungsten carbide shank is approximately three times higher than that of a steel shank. The modulus of elasticity indicates the amount of deformation a body undergoes as a result of a given load.

In internal grinding applications, tools with a tungsten carbide shank offer higher stock removal rates, superior surfaces and more precise shape and position tolerances.

A = stepped shank

N = non-stepped shank

Recommendations for use:

- Dry grinding: 15–25 m/s
- Wet grinding: 20–40 m/s

PFERDVALUE:

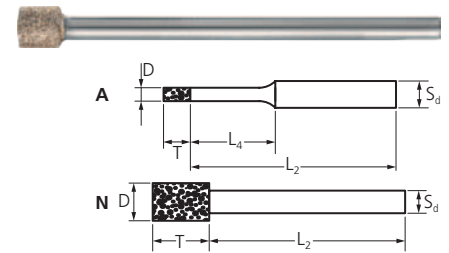

D x T [mm]	S _d [mm]	L ₂ [mm]	L ₄ [mm]	Grit size		Box icon	Description
				B 151	EAN 4007220		
Shank dia. 3 mm							
4.0 x 5	3	43	-	353714		1	BZY-N 4,0-5/3 HM B 151
5.0 x 5	3	43	-	353721		1	BZY-N 5,0-5/3 HM B 151
Shank dia. 6 mm							
6.0 x 6	6	98	19	353691		1	BZY-A 6,0-6/6 HM B 151
8.0 x 8	6	98	-	353738		1	BZY-N 8,0-8/6 HM B 151
12.0 x 8	6	98	-	956014		1	BZY-N 12,0-8/6 HM B 151

Spherical shape KU

Spherical shape CBN grinding points are often used for engraving, contour grinding and deburring work.

A = stepped shank

N = non-stepped shank

Recommendations for use:

- Dry grinding: 15–25 m/s
- Wet grinding: 20–40 m/s

PFERDVALUE:

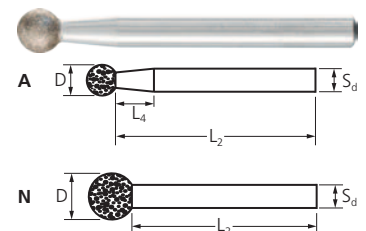

Ordering notes:

- Please complete the description with the desired grit size.

D [mm]	S _d [mm]	L ₂ [mm]	L ₄ [mm]	Grit size		Box icon	Description
				B 64	B 126		
Shank dia. 3 mm							
1.0	3	44	10	354957	258996	5	BKU-A 1,0/3 ...
2.0	3	43	8	354964	259023	5	BKU-A 2,0/3 ...
3.0	3	42	6	354971	259054	5	BKU-A 3,0/3 ...
4.0	3	41	5	-	259085	5	BKU-A 4,0/3 ...
5.0	3	40	2	-	259115	5	BKU-A 5,0/3 ...
6.0	3	39	-	-	259146	1	BKU-N 6,0/3 ...
Shank dia. 6 mm							
8.0	6	52	10	-	259207	1	BKU-A 8,0/6 ...
10.0	6	50	5	-	259269	1	BKU-A 10,0/6 ...
12.0	6	48	-	-	259320	1	BKU-N 12,0/6 ...

Diamond and CBN tools electroplated bond

CBN grinding points

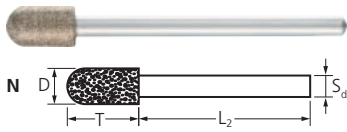

Cylindrical shape with radius end WR

The cylindrical shape with radius end WR is best suited to manual applications and can be used for a wide variety of deburring and grinding tasks.

N = non-stepped shank

Recommendations for use:

- Dry grinding: 15–25 m/s
- Wet grinding: 20–40 m/s

PFERDVALUE:



D x T [mm]	S _d [mm]	L ₂ [mm]	Grit size	Description
			B 126	
			EAN 4007220	
Shank dia. 3 mm				
5.0 x 10	3	40	354087	BWR-N 5,0-10/3 B 126
6.0 x 10	3	40	354094	BWR-N 6,0-10/3 B 126

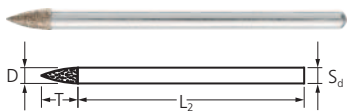

Pointed tree shape SPG

The pointed tree shape SPG is exceptionally well suited to machining small holes or bores as well as for engraving work.

Recommendations for use:

- Dry grinding: 15–25 m/s
- Wet grinding: 20–40 m/s

PFERDVALUE:



D x T [mm]	S _d [mm]	L ₂ [mm]	Grit size	Description
			B 126	
			EAN 4007220	
Shank dia. 3 mm				
3.0 x 7	3	43	354100	BSPG 3,0-7/3 B 126
Shank dia. 6 mm				
6.0 x 18	6	50	354117	BSPG 6,0-18/6 B 126

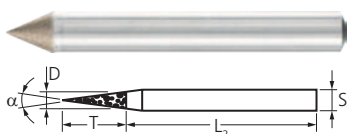

Conical pointed shape SK

The conical pointed shape SK is exceptionally well suited to deburring bores, regrinding centring holes and chamfering.



Recommendations for use:

- Dry grinding: 15–25 m/s
- Wet grinding: 20–40 m/s

PFERDVALUE:



D x T [mm]	α	S _d [mm]	L ₂ [mm]	Grit size	Description
				B 64	
			EAN 4007220		
Shank dia. 6 mm					
6.0 x 7	45°	6	50	393406	BSK 6,0-45°/6 B 64
6.0 x 5	60°	6	50	393413	BSK 6,0-60°/6 B 64

Grinding discs 1A1

CBN grinding discs are intended for use on stationary machines. The grinding discs have an additional centring shoulder which allows them to be accurately mounted and aligned on the machine spindle.

Combined with a stable mandrel, these tools are ideal for work in deep-set or long bores.

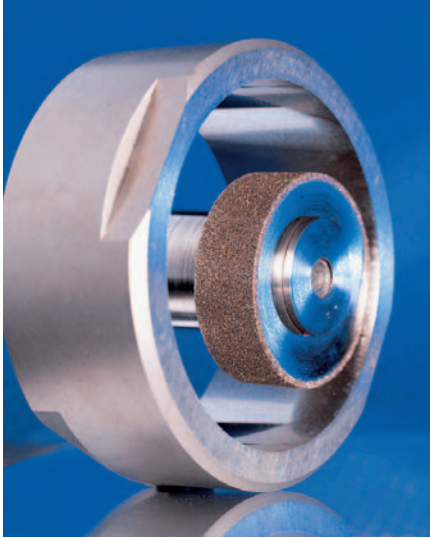

Recommendations for use:

- Dry grinding: 15–25 m/s
- Wet grinding: 20–40 m/s

PFERDVALUE:



Emission Filter



Energy Saving



Waste Saving



Time Saving



Resource Saving

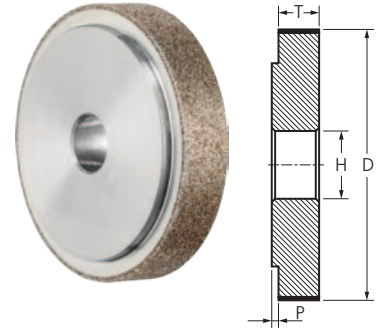

D x T [mm]	H [mm]	P [mm]	Grit size		Description
			B 151		
			EAN 4007220		
20.0 x 10	8	2	355015	1	B1A1 20-10-8 B 151
30.0 x 10	10	2	355039	1	B1A1 30-10-10 B 151
40.0 x 10	10	2	355053	1	B1A1 40-10-10 B 151
50.0 x 10	10	2	355077	1	B1A1 50-10-10 B 151



Diamond and CBN tools electroplated bond

Diamond cut-off wheels

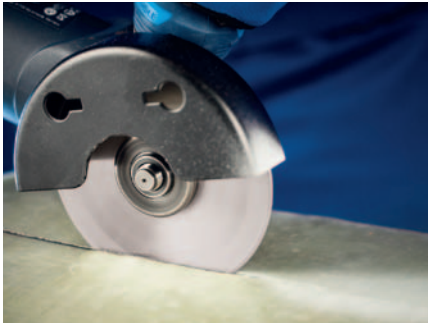

Electroplated diamond cut-off wheels are characterized by their particularly efficient cutting performance because of their large chip spaces.

Matching tool drives:

- Angle grinders
- Flexible shaft drives
- Straight grinders
- Stationary machines

Note:

- Other dimensions and CBN cut-off wheels are available on request. Further information on customer-specific tool solutions can be found on page 14.

Advice on tool selection:

- When cutting glass, ceramic or tungsten carbide, use fine grit sizes D 64 or D 151.
- When cutting pre-sintered ceramic, use coarse grit sizes D 357 or D 427.
- For cutting, trimming or cutting-to-length work on fibre-reinforced plastics (GRP/CRP), use coarse grit sizes D 357 or D 427. Fine grit sizes D 64 and D 151 can also be used for small geometries.
- The grit size D 852 is exceptionally well-suited to machining grey cast iron and nodular cast iron (GG and GGG or GJL and GJS).

Shape D
(continuous coating)



The continuous coating is particularly suitable for very fine separating cuts.

Shape G
(with protective segments)

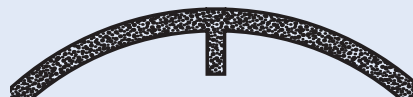

The continuous coating with protective segments facilitates optimum free-cutting.

Shape S 2
(segmented)



The segmentation allows particularly good chip removal.



Diamond cut-off wheels

Electroplated diamond cut-off wheels are used with grit sizes from D 64 to D 427 for cutting hard materials such as tungsten carbide or ceramics and fibre-reinforced plastics (GRP/CRP).

PFERDVALUE:

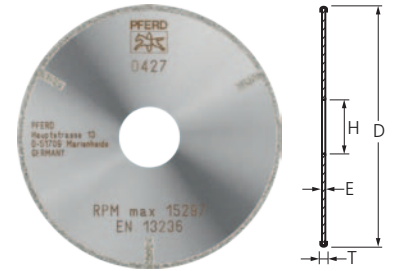

D [mm]	T [mm]	E [mm]	H [mm]	Shape	Protective segments per side	Grit size				Description
						D 64	D 151	D 357	D 427	
						EAN 4007220				

Hard materials, e.g. glass, ceramics or tungsten carbide

22	0.5	0.3	1.7	D	none	355190	-	-	-	1	D1A1R 22-0,5-1,7 D 64 GAD
30	1.0	0.6	10	D	none	-	355206	-	-	1	D1A1R 30-1-10 D 151 GAD
40	1.0	0.6	10	D	none	-	355213	-	-	1	D1A1R 40-1-10 D 151 GAD
50	1.4	1.0	6	D	none	-	355220	-	-	1	D1A1R 50-1,4-6 D 151 GAD
			10	D	none	-	666043	-	-	1	D1A1R 50-1,4-10 D 151 GAD
125	1.4	1.0	20	D	none	-	355237	-	-	1	D1A1R 125-1,4-20 D 151 GAD

Fibre-reinforced plastics (GRP and CRP) as well as pre-sintered and green ceramic

50	2.0	1.0	6	D	none	-	-	308790	-	1	D1A1R 50-2-6 D 357 GAD
			6	G	3	-	-	168530	-	1	D1A1R 50-2-6 D 357 GAG
			10	D	none	-	-	666067	-	1	D1A1R 50-2-10 D 357 GAD
			10	G	3	-	-	666050	-	1	D1A1R 50-2-10 D 357 GAG
75	2.0	1.0	10	D	3	-	-	956038	-	1	D1A1R 75-2-10 D 357 GAD
			10	G	3	-	-	393420	-	1	D1A1R 75-2-10 D 357 GAG
100	2.0	1.0	22.23	D	none	-	-	-	805992	1	D1A1R 100-2-22,23 D 427 GAD
			22.23	G	3	-	-	-	806005	1	D1A1R 100-2-22,23 D 427 GAG
115	2.0	1.0	22.23	D	none	-	-	-	806012	1	D1A1R 115-2-22,23 D 427 GAD
			22.23	G	3	-	-	-	806029	1	D1A1R 115-2-22,23 D 427 GAG
125	2.0	1.0	22.23	D	none	-	-	-	806036	1	D1A1R 125-2-22,23 D 427 GAD
			22.23	G	3	-	-	-	806043	1	D1A1R 125-2-22,23 D 427 GAG
178	2.0	1.0	22.23	D	none	-	-	-	806050	1	D1A1R 178-2-22,23 D 427 GAD
230	2.5	1.5	22.23	S2	none	-	-	-	806074	1	D1A1RSS 230-2,5-22,23 D 427 GAS2
250	2.5	1.5	22.23	S2	none	-	-	-	806081	1	D1A1RSS 250-2,5-22,23 D 427 GAS2
300	2.5	1.5	30	S2	none	-	-	-	806098	1	D1A1RSS 300-2,5-30,0 D 427 GAS2
350	2.8	1.8	30	S2	none	-	-	-	806104	1	D1A1RSS 350-2,8-30,0 D 427 GAS2
400	3.8	2.8	30	S2	none	-	-	-	806111	1	D1A1RSS 400-3,8-30,0 D 427 GAS2

Arbors for diamond cut-off wheels

Accessories for mounting diamond cut-off wheels up to a diameter of 75 mm.

Safety notes:

- For safety reasons, it is imperative to remain within the stated rotational speed limit.

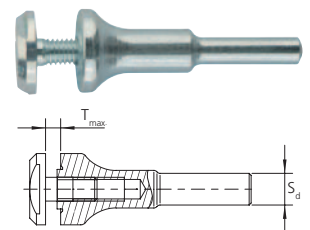

S _d [mm]	Suitable for centre hole dia. [mm]	T _{max} [mm]	EAN 4007220	Max. RPM	Description
3	1.7	1.0	443606	28,000	BO 3/1,7 1
6	10	3.0	956045	30,000	BO 6/10 3
8	10	3.0	806401	30,000	BO 8/10 3

Diamond and CBN tools electroplated bond

Diamond cut-off wheels and grinding points for foundries

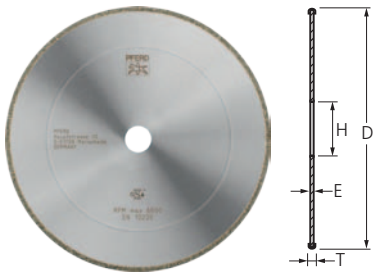

Diamond cut-off wheels for grey and nodular cast iron

Electroplated diamond cut-off wheels with grit size D 852 are exceptionally well suited to machining grey cast iron and nodular cast iron (GG and GGG or GJL and GJS) as well as for use in robots. The diameter of 230 mm is suitable for standard angle grinders; the diameter of 400 mm is suitable for stationary applications.

Advantages:

- Very long tool life.
- Ideal for work on deep-lying areas because of the constant tool diameter.
- Easy and quick elimination of metal contamination.
- Minimized dust formation due to the monolayer coating and coarse chips.

Materials that can be worked:

grey/nodular cast iron (GG/GJL, GGG/GJS)

Matching tool drives:

angle grinder, stationary machines

Accessories:

- Clamping flange set SFS 76 for thin 180/230 mm cut-off wheels helps to reduce noise development during manual grinding (M14 thread: EAN 4007220**595275**, 5/8" thread: EAN 4007220**895856**).



PFERDVALUE:



D [mm]	T [mm]	E [mm]	H [mm]	Shape	Protective segments per side	Grit size		Description
						D 852	EAN 4007220	

Grey and nodular cast iron (GG and GGG or GJL and GJS)

230	3.8	1.8	22.23	D	none	956021	1	D1A1R 230-3,8-22,23 D 852 GAD
400	4.5	2.5	40	D	none	947449	1	D1A1R 400-4,5-40,0 D 852 GAD

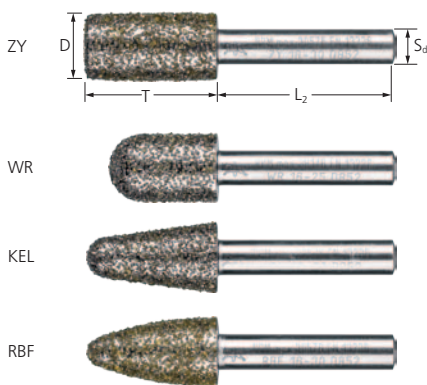

Diamond grinding points for grey and nodular cast iron

Diamond grinding points with grit size D 852 are exceptionally well suited to machining grey cast iron and nodular cast iron (GG and GGG or GJL and GJS).

Advantages:

- Outstanding tool life.
- Fast, aggressive grinding with the highest possible stock removal rate.
- Easy and quick elimination of metal contamination thanks to diamond as a super-hard abrasive.
- Low dust load due to the dimensional stability of the grinding tool (no tool wear).

Materials that can be worked:

grey/nodular cast iron (GG/GJL, GGG/GJS)

Applications:

grinding out, weld dressing, deburring

Recommendations for use:

- Dry grinding: 30–50 m/s

Matching tool drives:

flexible shaft drives, straight grinder, stationary machines

D x T [mm]	S _d [mm]	L ₂ [mm]	Grit size		Description
			D 852	EAN 4007220	

Cylindrical shape ZY

16.0 x 30	8	40	103708	1	DZY-N 16-30/8 D 852
20.0 x 30	8	40	103753	1	DZY-N 20-30/8 D 852

Cylindrical shape with radius end WR

10.0 x 20	6	40	097366	1	DWR-N 10-20/6 D 852
12.0 x 25	6	40	097373	1	DWR-N 12-25/6 D 852
16.0 x 25	8	40	097472	1	DWR-N 16-25/8 D 852

Conical shape with radius end KEL

16.0 x 30	8	40	097489	1	DKEL-N 16-30/8 D 852
-----------	---	----	--------	---	----------------------

Tree shape with radius end RBF

12.0 x 25	6	40	102800	1	DRBF-N 12-25/6 D 852
16.0 x 30	8	40	103692	1	DRBF-N 16-30/8 D 852



Customer-specific tool solutions for grey and nodular cast iron

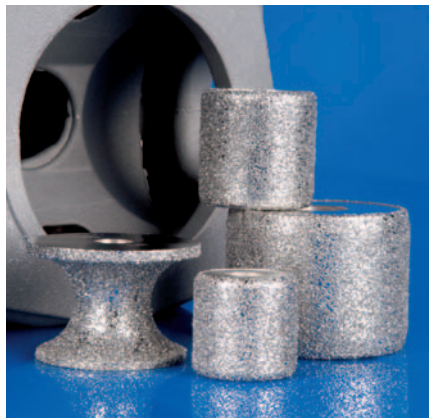
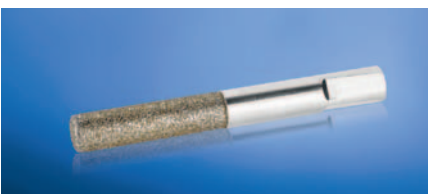

More informationen about customer-specific tool solutions can be found on page 14.

Diamond and CBN tools electroplated bond

Diamond grinding discs CC-GRIND-SOLID-DIAMOND

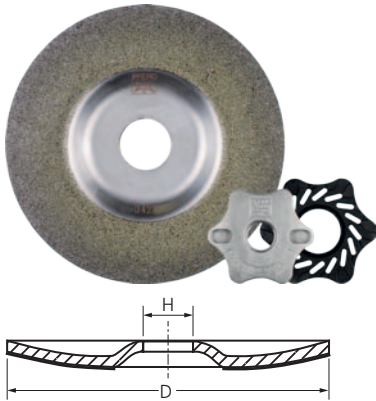

CC-GRIND-SOLID-DIAMOND

The CC-GRIND-SOLID-DIAMOND has been specially developed for applications on hard materials which cannot be machined with conventional tools made of aluminium oxide or silicon carbide.

Materials that can be worked:

scale, wear-resistant coatings (powder metal alloys and hardfacing alloys), technical ceramics, fibre-reinforced duroplastics (GRP, CRP), tungsten carbide, nickel- or titanium-based superalloys, grey/nodular cast iron (GG/GJL, GGG/GJS)

Recommendations for use:

- Only use the face of the disc, not suitable for peripheral grinding.
- To extend the tool life of the grinding disc on scale and wear-resistant coatings, reduce the cutting speed of the speed-adjustable angle grinder to 30 to 40 m/s.
- For optimum results, use with the CC-GRIND-SOLID/FLEX clamping flange set.
- When used on angle grinders with a 5/8-11 thread, the matching clamping flange set must be ordered separately.

Ordering notes:

- Matching clamping flange set (M14 thread) is included in delivery.

PFERDVALUE:

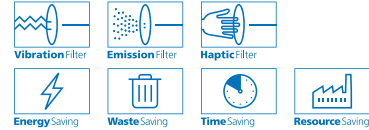

D [mm]	H [mm]	Grit size		Included clamping flange set	Max. RPM		Description
		D 427	D 852				
		EAN 4007220					
100	16.0	068335	068366	SFS CC-GRIND-SOLID 100 M10	15,300	1	CC-GRIND-SOLID-DIAMOND 100-16,0 ...
115	22.23	068342	068373	SFS CC-GRIND-SOLID 115/125 M14	13,300	1	CC-GRIND-SOLID-DIAMOND 115-22,23 ...
125	22.23	068359	068380	SFS CC-GRIND-SOLID 115/125 M14	12,200	1	CC-GRIND-SOLID-DIAMOND 125-22,23 ...



Matching clamping flange set with 5/8-11 drive spindle thread:

SFS CC-GRIND-SOLID

115/125 5/8" (EAN 4007220**887592**):
For detailed information and ordering data, please refer to catalogue section 6.



For more information about the CC-GRIND product range, please refer to catalogue section 6.



Diamond sabre saw blades



Diamond sabre saw blades

Diamond sabre saw blades are exceptionally well suited to work on fibre-reinforced plastics (GRP/CRP), e.g. for making cut-outs in container construction or for cutting prefabricated slabs. They are characterized, in particular, by their flexible cutting lines for producing a wide range of geometries and by their long tool life. Suitable for all Bosch-socket sabre saws.

Materials that can be worked:

fibre-reinforced duroplastics (GRP, CRP)

Matching tool drives:

sabre saw

Applications:

cutting out holes, cutting

Overall length [mm]	Total width [mm]	Coating length [mm]	Grit size			Description
			D 357			
			EAN 4007220			
75	2	50	535950		1	DIA-SSB 50/75 D 357
100	2	75	535967		1	DIA-SSB 75/100 D 357

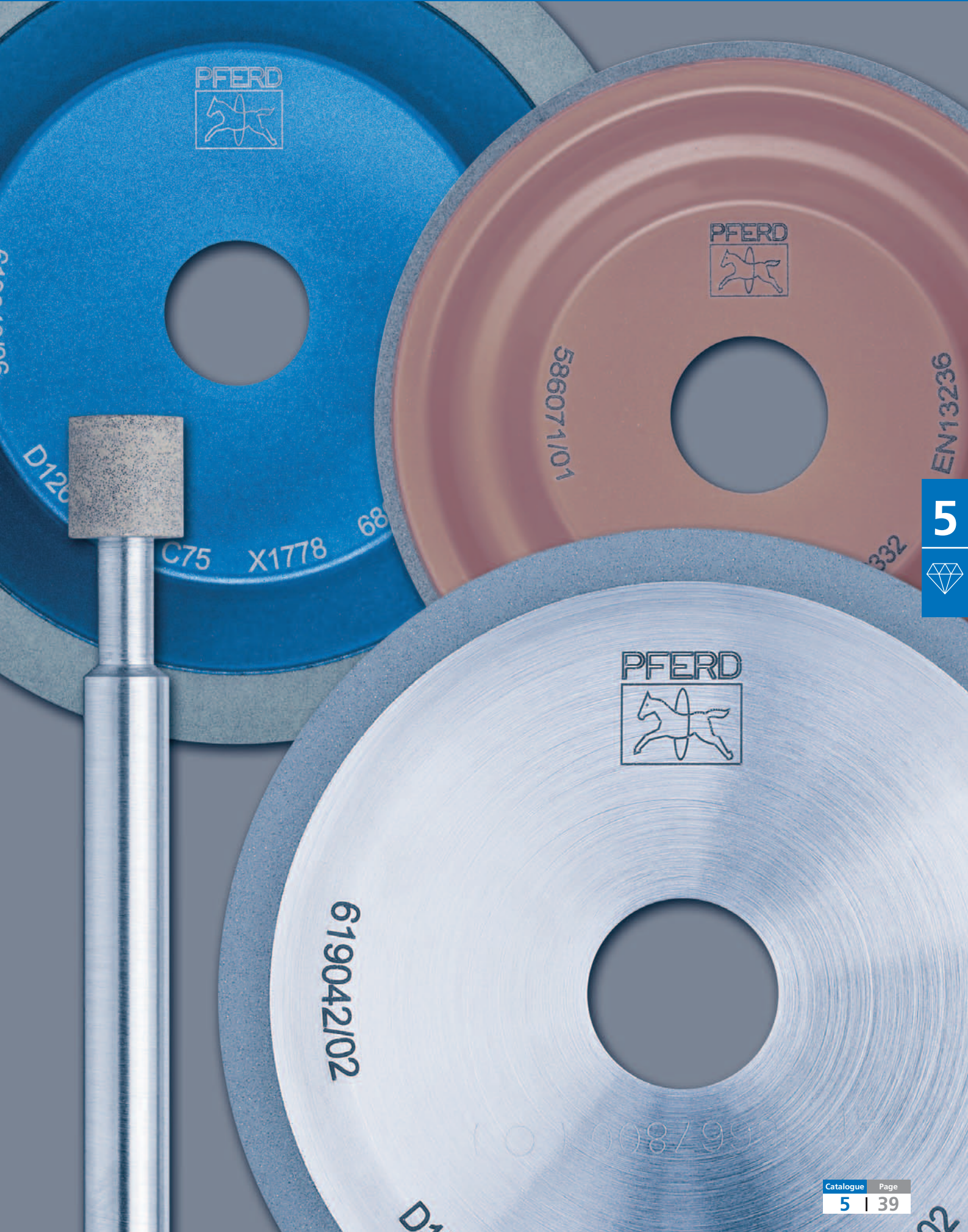

Diamond and CBN tools resinoid bond

General information



Resinoid-bonded diamond and CBN grinding discs are often used for grinding tungsten carbide or HSS tools, as well as in other production grinding processes. They are used in both wet and dry grinding.

Advantages:

- The characteristics of the resinoid bond can be optimally adjusted to the application.
- Easy to dress.

Matching tool drives:

- Machine tool

Recommendations for use:

- A larger diameter D allows greater profitability thanks to the improved thermal and kinematic conditions.
- Always select a coating width, W or U, that is narrower than the workpiece to be ground.
- A larger coating thickness, X, affects the material cost for diamond or CBN and the bond. It has only little influence on production costs, however. A larger coating thickness, X, is therefore generally more economical.
- Please observe the recommended cutting speeds on page 10.

Dressing

Tools with resinoid bonds are easy to dress. Different tool contours can be worked with the same tools. After dressing, ensure that the coating is worked on using sharpening block SBL 1002413, so that the easy cutting characteristics of the tool are regained. More detailed information and ordering data can be found on page 43.

Coolant

If possible, wet grinding is to be preferred to dry grinding. This reduces tool wear and the risk of thermal damage to the workpiece. Bonds that are designed for dry grinding may, in exceptional circumstances, also be used for wet grinding.

Diamond grinding discs:

Emulsion 1–5 %

CBN grinding discs:

Low-viscosity mineral oils or emulsions (5–8 %) with EP additives

Concentration information	Carat weight per cm ³ of coating volume [ct/cm ³]	Grit volume in % of the abrasive coating
C 25	1.1	6.25
C 38	1.65	9.50
C 50	2.2	12.50
C 75	3.3	18.75
C 100	4.4	25.00
C 125	5.5	31.25

Concentration

The concentration is the amount of grit in carats [ct] (= 0.2 g) per cubic centimetre of abrasive coating. A concentration of C 100 corresponds to 4.4 ct/cm³ and around 25 % of the volume of the abrasive in the total bond. The usual spread of the concentration can be seen in the table on the left.

A high concentration makes the tool more resistant to wear. This characteristic is particularly desirable in all profile grinding tasks.

As a rule, the longer tool life resulting from a high concentration compensates the higher tool costs (caused by the higher diamond or CBN grit volume). Please note that a high concentration can cause larger grinding forces and higher process temperatures. Therefore, it is not always the best solution in technological and economical terms.

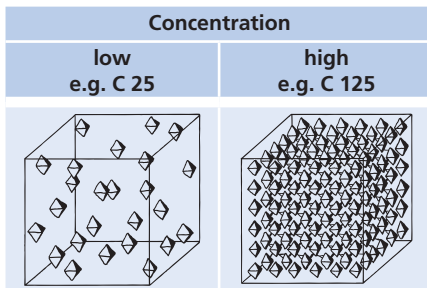

Bond types

PHT	PHN	PH 4.1 (only CBN)	PH 4.2 (only CBN)	PHST
Phenolic resin bond for high-performance dry grinding. The PHT bond is designed for dry grinding and allows cool grinding, even without coolant.	Phenolic resin bond for high-performance wet grinding. The PHN bond is designed for wet grinding. It is comparatively hard and offers an excellent tool life and dimensional stability.	Phenolic resin bond for the highest stock removal rates. Very long tool life. Suitable for dry and wet grinding.	High-performance bond for cool dry grinding at low infeed rates. Only for 11V9 and 12V9 up to diameter 150 mm.	Phenolic resin bond for dry grinding at very high stock removal rates. The PHST bond type can withstand higher loads, i.e. it allows a higher infeed per stroke without thermal damage to the workpiece. Inevitably, the reduction in grinding time is obtained at the expense of a slightly shorter tool life.

In addition to the listed bond types, a wide range of special bonds is available, which, in consultation with our technical advisers, can be used for special grinding work. Our technical advisers will be happy to provide a consultation at any time.

Shape 11V9

Shape	D - X - U - H [mm]	Bond	Grit concentration	Grit size	EAN 4007220	
11V9	100 - 2 - 10 - 20	PHT	C 75	D 126	168592	1
	100 - 3 - 10 - 20	PHST	C 75	D 126	168622	1

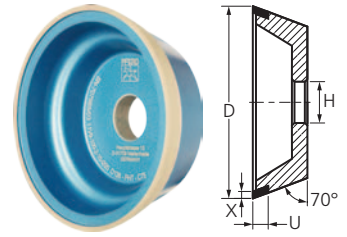

Shape 12V9

Shape	D - X - U - H [mm]	Bond	Grit concentration	Grit size	EAN 4007220	
12V9	100 - 2 - 10 - 20	PHT	C 75	D 126	168646	1

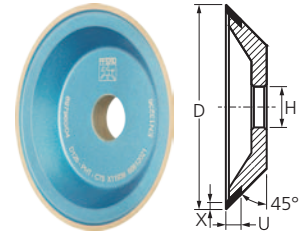

Shape 11A2/60°

Shape	D - W - X - H [mm]	Bond	Grit concentration	Grit size	EAN 4007220	
11A2/60°	100 - 8 - 2 - 20	PHT	C 75	D 64	261965	1
				D 126	261972	1

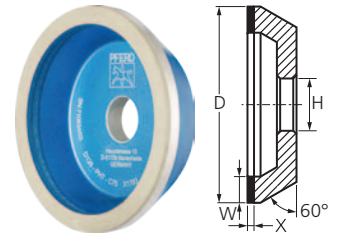

Shape 12A2/45°

Shape	D - W - X - H [mm]	Bond	Grit concentration	Grit size	EAN 4007220	
12A2/45°	125 - 10 - 2 - 20	PHT	C 50	D 64	168677	1
				D 126	168660	1

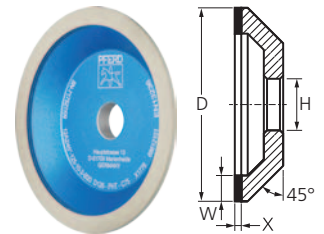

Shape 12C9

Shape	D - W - U - X - H [mm]	Bond	Grit concentration	Grit size	EAN 4007220	
12C9	100 - 10 - 4 - 3 - 20	PHT	C 75	D 126	956052	1

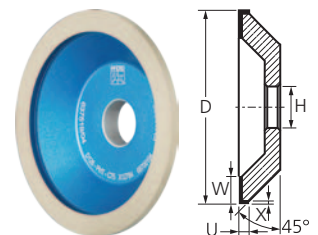

Shape 4BT9

Shape	D - W - X - H [mm]	Bond	Grit concentration	Grit size	EAN 4007220	
4BT9	100 - 6 - 1 - 20	PHT	C 75	D 126	350119	1

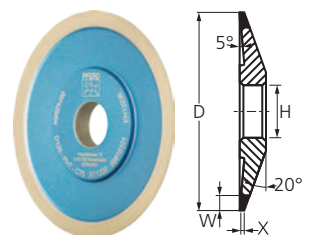

Diamond and CBN tools resinoid bond

Diamond grinding tools

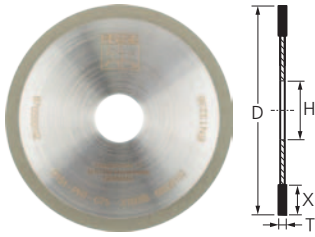

Shape 1A1R

Shape	D - T - X - H [mm]	Bond	Grit concentration	Grit size	EAN 4007220	
1A1R	100 - 1 - 5 - 20	PHT	C 75	D 151	350096	1
	150 - 1 - 7 - 20	PHT	C 75	D 151	806357	1

CBN grinding tools

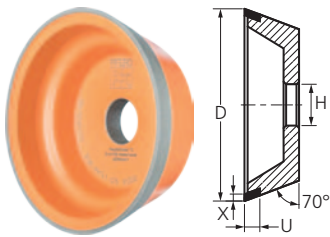

Shape 11V9

Shape	D - X - U - H [mm]	Bond	Grit concentration	Grit size	EAN 4007220	
11V9	100 - 2 - 10 - 20	PH 4.1	C 75	B 126	350171	1
		PH 4.2	-	B 151	535646	1

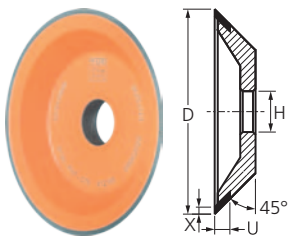

Shape 12V9

Shape	D - X - U - H [mm]	Bond	Grit concentration	Grit size	EAN 4007220	
12V9	100 - 2 - 10 - 20	PHT	C 75	B 126	168707	1

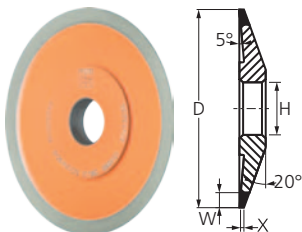

Shape 4BT9

Shape	D - W - X - H [mm]	Bond	Grit concentration	Grit size	EAN 4007220	
4BT9	100 - 6 - 1 - 20	PHT	C 75	B 126	350126	1

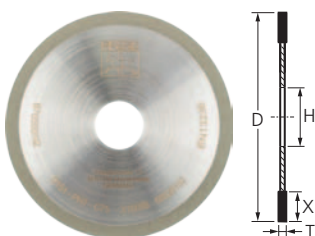

Shape 1A1R

Shape	D - T - X - H [mm]	Bond	Grit concentration	Grit size	EAN 4007220	
1A1R	100 - 1 - 5 - 20	PHT	C 100	B 151	350102	1

Sharpening block for diamond and CBN tools

The sharpening block is used to restore the sharpness of resinoid-bonded diamond and CBN grinding discs (e.g. after dressing with a diamond dressing tool).

The sharpening block is first soaked in coolant and then in-fed manually or by means of a suitable feeding device. Grinding with the sharpening block will quickly restore the sharpness of your grinding disc.

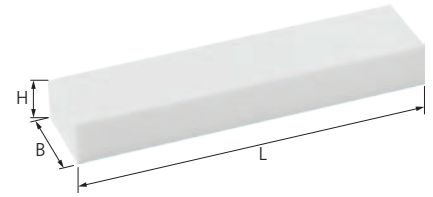

L [mm]	B [mm]	H [mm]	EAN 4007220		Description
100	24	13	255605	5	SBL 1002413

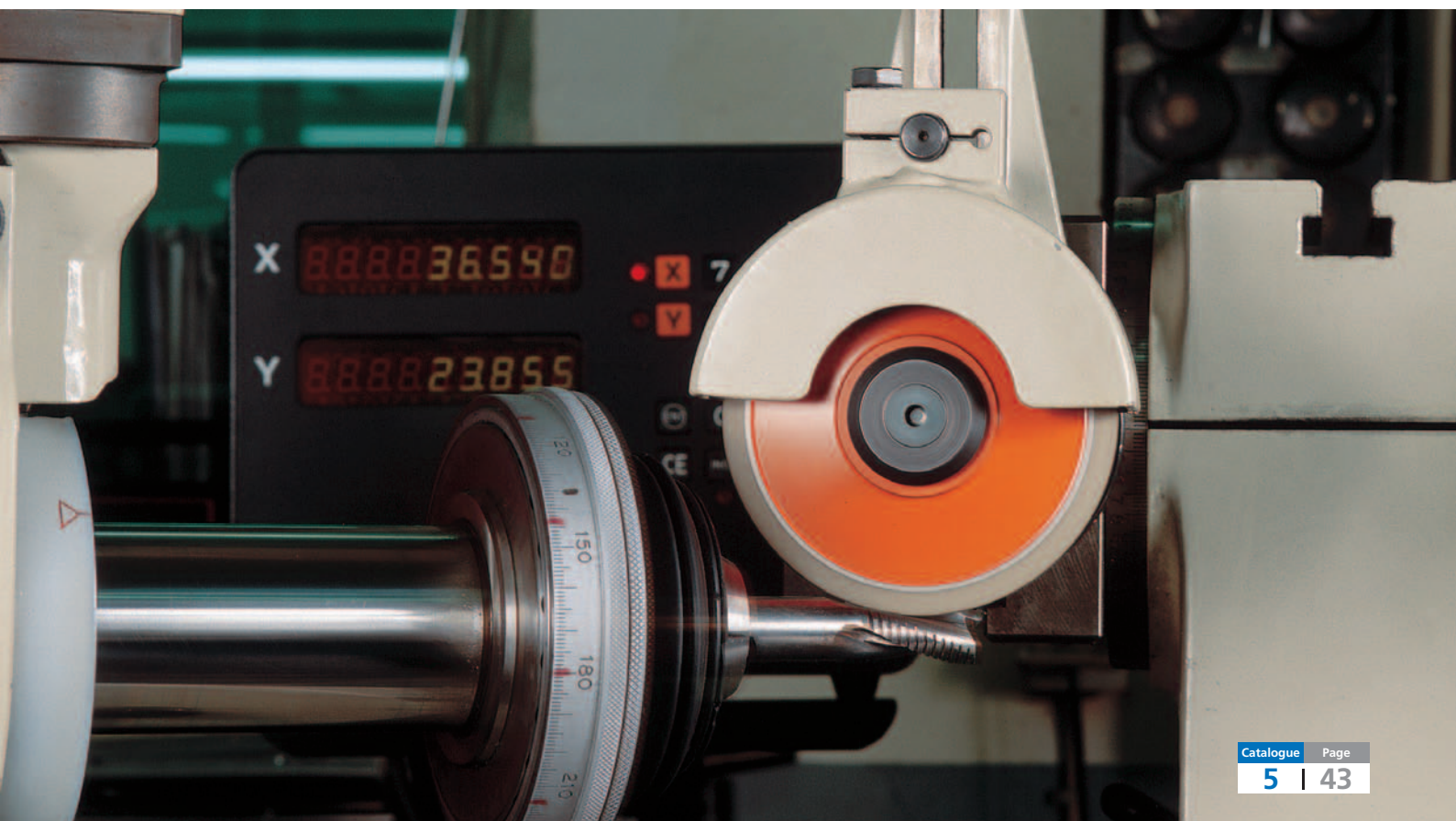

Diamond and CBN tools resinoid bond

Customer-specific tool solutions

In addition to the standard resinoid-bonded diamond and CBN grinding tools available from stock, customer-specific tool solutions are also possible.

In your request, please specify the material to be worked, the application and the tool drive.

In the following tables, all the available shapes and dimensions are shown. For dimensions separated by slashes, please select the desired dimension.

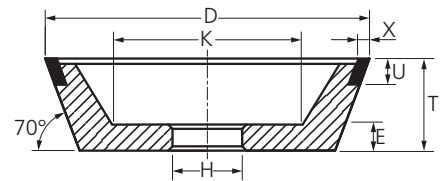

Description explanation based on ISO 6104:

11V9 100 - 2 - 10 - 20 D126 PHT C75

① ② ③ ④ ⑤ ⑥ ⑦ ⑧

- ① Designation and shape of the tool according to ISO 6104
- ② Outer dia. D [mm]
- ③ Usable abrasive coating thickness X [mm]
- ④ Coating width U [mm]
- ⑤ Bore diameter H [mm]
- ⑥ Grit size (D = diamond, B = CBN)
- ⑦ Bond type
- ⑧ Grit concentration (C)

Abbreviation	Comment
α	Mount angle
D [mm]	Outer diameter
E [mm]	Bottom thickness
H [mm]	Bore diameter
J [mm]	Smaller diameter

Abbreviation	Comment
K [mm]	Internal diameter
L_2 [mm]	Shank length
L_4 [mm]	Reduced diameter length
R [mm]	Radius
S_1 [mm]	Reduced diameter

Abbreviation	Comment
S_d [mm]	Shank diameter
T [mm]	Total width
U [mm]	Coating width
W [mm]	Mounted point width
X [mm]	Usable abrasive coating thickness

Shape 1A1

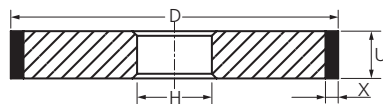

D [mm]	U [mm]	X [mm]	H [mm]
50	4 / 6 / 8 / 10 / 12	3 / 4 / 5 / 6	Please specify
75	6 / 8 / 10 / 12	3 / 4 / 5 / 6	
100	6 / 8 / 10 / 12	3 / 4 / 5 / 6	
125	8 / 10 / 12 / 15	3 / 4 / 5 / 6	
150	8 / 10 / 12 / 15 / 20	3 / 4 / 5 / 6	
175	10 / 12 / 15 / 20	3 / 4 / 5	
200	12 / 15 / 20 / 25 / 30	3 / 4 / 5 / 6	
225	12 / 15 / 20	3 / 4 / 5	
250	15 / 20 / 25 / 30 / 40 / 50	3 / 4 / 5	
300	15 / 20 / 25 / 30 / 40 / 50	3 / 4 / 5 / 6	
350	20 / 25 / 30 / 40 / 50	3 / 4 / 5 / 6	
400	25 / 30 / 40 / 50	3 / 4 / 5 / 6	
450	25 / 30 / 40 / 50	3 / 4 / 5 / 6	
500	30 / 40 / 50	3 / 4 / 5 / 6	
600	35 / 40	3 / 5	

Ordering example: 1A1 200-20-4-127 D 126 PHN C 75

Shape 1FF1

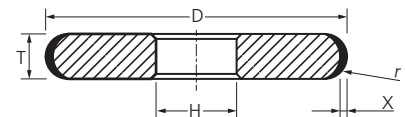

D [mm]	T [mm]	X [mm]	R [mm]	H [mm]
50	6	2	3	Please specify
	8		4	
	10		5	
75	6		3	
	8		4	
	10		5	
100	6		3	
	8		4	
	10		5	
125	6		3	
	8		4	
	10		5	
150	12	6		
	6	3		
	8	4		
	10	5		
	12	6		

Ordering example: 1FF1 150-8/4R-2-32 D 126 PHN C 75

Shape 4A2

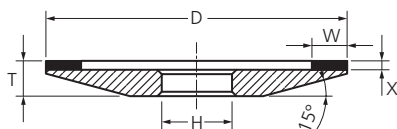

D [mm]	W [mm]	X [mm]	H [mm]	T - X [mm]
50	3 / 5	2 / 3 / 4	Please specify	5
75	3 / 5			5
100	3 / 4 / 5 / 6 / 8 / 10			6
125	3 / 4 / 5 / 6 / 8 / 10			7
150	3 / 4 / 5 / 6 / 8 / 10 / 12.5			9

Ordering example: 4A2 100-4-2-20 D 64 PHT C 50

Shape 4BT9

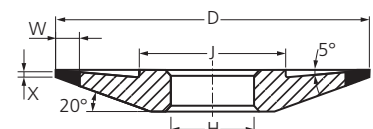

D [mm]	W [mm]	X [mm]	H [mm]	T [mm]	J [mm]
75	6	1	Please specify	8	36
100	6 / 10	1		10	50
125	6 / 10	1		12	65
150	6 / 10	1		15	80

Ordering example: 4BT9 100-6-1-20 D 126 PHN C 75

Other dimensions on request!

Shape 1A1W

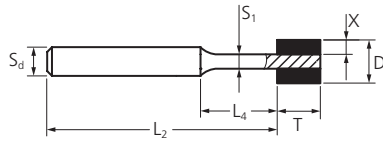

D [mm]	T [mm]	X [mm]	S _d [mm]	L ₂ [mm]	S ₁ [mm]	L ₄ [mm]
3	6	0.75	3	60	1.5	8
4	6	1	3	60	2	8
5	6	1.5	3	60	2	8
6	6	1.5	6	60	3	8
6	8	1.5	6	60	3	10
7	6	2	6	60	3	8
8	6	2	6	60	4	8
8	10	2	6	60	4	12
9	6	2	6	60	5	8

Ordering example: 1A1W 8-6-2-6-60-4-8 D 91 PHNT C 100

Shape 1A1W

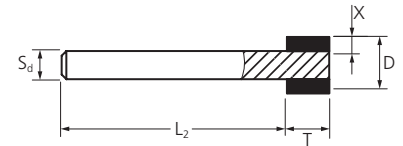

D [mm]	T [mm]	X [mm]	S _d [mm]	L ₂ [mm]
10	6	2	6	60
	10	2	6	60
12	6	2	6	60
	10	2	6	60
15	6	2	6	60
	10	2	6	60
18	6	2	6	60
	10	2	6	60
20	6	2	6	60
	10	2	6	60

Ordering example: 1A1W 15-10-2-6-60 D 91 PHNT C 100

Shape 1A1R

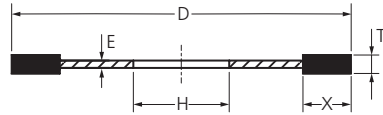

D [mm]	T [mm]	X [mm]	H [mm]	E [mm]
75	1	5	H ≥ 20 mm	0.8
100	1	5		0.8
125	1	5	Please specify	0.8
150	1	7		0.8
175	1.2	7		0.9
200	1.2	7		0.9

Ordering example: 1A1R 150-1-7-20 D 151 PHT C 75

Shape 6A2

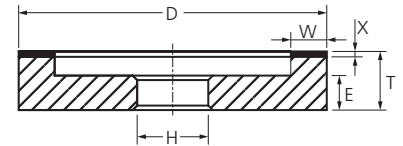

D [mm]	W [mm]	X [mm]	H [mm]	T - X [mm]	E [mm]
50	3 / 5	2 / 3 / 4	Please specify	20	10
75	3 / 5 / 10			20	10
100	5 / 8 / 10 / 12.5 / 15			20	10
125	4 / 6 / 8 / 10 / 12.5 / 15 / 20 / 25			23	10
150	6 / 8 / 10 / 12.5 / 15 / 20 / 25			23	10

Ordering example: 6A2 125-10-2-20 D 126 PHT C 50

Shape 1V1

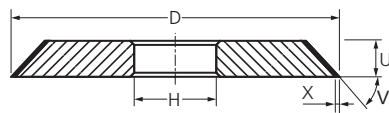

D [mm]	U [mm]	X [mm]	V	H [mm]
50	6 / 8	3 / 4	20° to 89°	Please specify
75	6 / 8 / 10			
100	8 / 10		Please specify	
125	8 / 10			
150	8 / 10			
175	10			
200	12 / 15			
250	15 / 20			
300	15 / 20			

Ordering example: 1V1 150-8-3/60°-32 B 126 PHN C 75

Shape 6A9

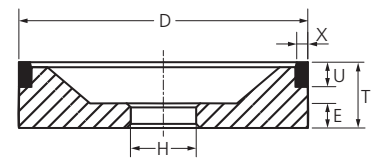

D [mm]	X [mm]	U [mm]	H [mm]	T [mm]	E [mm]
75	1.5	6 / 10	Please specify	25	10
	2	6 / 10		25	10
	3	6 / 10		25	10
100	1.5	6 / 10		30	10
	2	6 / 10		30	10
	3	6 / 10		30	10
125	1.5	6 / 10		30	10
	2	6 / 10		30	10
	3	6 / 10		30	10
150	1.5	6 / 10		35	10
	2	6 / 10		35	10
	3	6 / 10		35	10

Ordering example: 6A9 100-2-10-20 D 126 PHN C 100

Other dimensions on request!

Diamond and CBN tools resinoid bond

Customer-specific tool solutions

Shape 9A3

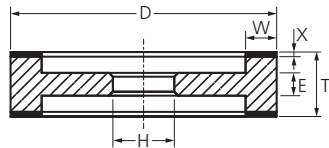

D [mm]	W [mm]	X [mm]	T [mm]	H [mm]	E [mm]
100	6 / 8 / 10	2 / 3	22	Please specify	10
125	6 / 8 / 10		22		10
150	4 / 6 / 8 / 10 / 15	25 / 35	25 / 35		14
175	3 / 4 / 6 / 8 / 10 / 15		25 / 35		14
200	8 / 10 / 15		30		18

Ordering example: 9A3 150-8-2-25-20 D 64 PHN C 75

Shape 12A2/20°

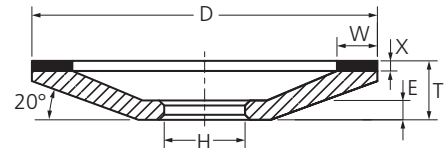

D [mm]	W [mm]	X [mm]	H [mm]	T - X [mm]	E [mm]
75	3 / 5 / 6 / 8 / 10	2 / 3 / 4	Please specify	8	5
100	3 / 5 / 6 / 8 / 10			10	6
125	5 / 6 / 8 / 10			14	8
150	5 / 6 / 8 / 10			16	9
175	6 / 10			18	10
200	6 / 10			20	11
250	6 / 10			23	13

Ordering example: 12A2/20° 125-10-2-20 D 126 PHT C 50

Shape 11A2

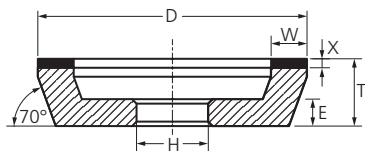

D [mm]	W [mm]	X [mm]	H [mm]	T - X [mm]	E [mm]
50	3 / 6	2 / 3 / 4	Please specify	20	8
75	3 / 6 / 10			20	10
100	4 / 6 / 8 / 10			20	10
125	5 / 6 / 8 / 10 / 12.5 / 15			23	10
150	6 / 8 / 10 / 12.5 / 15			23	10
175	6 / 10 / 12.5 / 15			25	12

Ordering example: 11A2 125-10-2-20 D 126 PHT C 50

Shape 12A2/45°

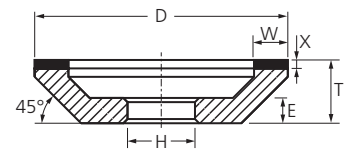

D [mm]	W [mm]	X [mm]	H [mm]	T - X [mm]	E [mm]
50	3 / 6	2 / 3 / 4	Please specify	15	8
75	3 / 6 / 10			20	9
100	4 / 6 / 8 / 10			23	10
125	5 / 6 / 8 / 10 / 12.5 / 15			23	10
150	6 / 8 / 10 / 12.5 / 15			23	10
175	6 / 10 / 12.5 / 15			25	12

Ordering example: 12A2/45° 125-10-2-20 D 126 PHT C 50

Shape 11V9

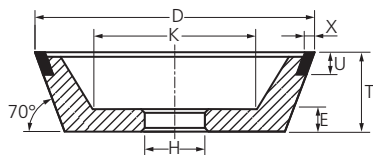

D [mm]	X [mm]	U [mm]	H [mm]	T [mm]	E [mm]	K [mm]
50	2	10	Please specify	30	10	22
75	1.5 / 2 / 3	10		30	10	41
100	1.5 / 2 / 3	10		35	10	60
125	1.5 / 2 / 3	10		40	10	75
150	1.5 / 2 / 3	10		50	10	89

Ordering example: 11V9 100-2-10-20 D 126 PHT C 75

Shape 12C9

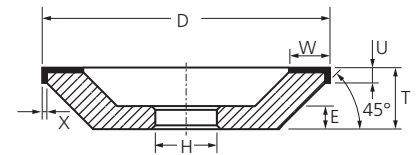

D [mm]	W [mm]	U [mm]	X [mm]	H [mm]	T [mm]	E [mm]
100	6 / 10	4	2	Please specify	26	10
	10	4	3		27	10
125	6 / 10	4	2		26	10
	10	4	3		27	10
150	12.5	5	2		26	10
	10	4	2		26	10
	10	4	3		27	10
	12.5 / 15	5	2		26	10

Ordering example: 12C9 100-10-4-2-20 D 64 PHN C 75

Shape 12V9

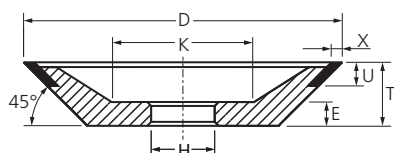

D [mm]	X [mm]	U [mm]	H [mm]	T [mm]	E [mm]	K [mm]
50	2	6	Please specify	20	10	24
75	2 / 3	10		20	10	41
100	1.5 / 2 / 3	10		20	10	62
125	1.5 / 2 / 3	10		25	10	76
150	2 / 3	10		25	10	97

Ordering example: 12V9 100-2-10-20 D 126 PHT C 75

Other dimensions on request!

Shape 14A1

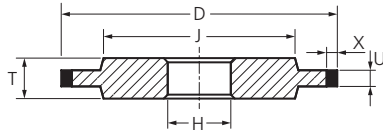

Shape 3A1

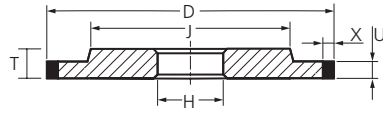

Shape 14F1

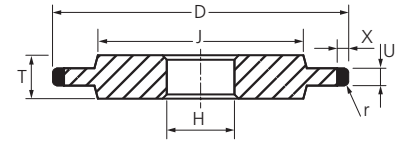

D [mm]	U [mm]	X [mm]	H [mm]	T [mm]	J [mm]
75	1/2	3/6	Please specify	6	50
	3/4/5	3/4/6		6	50
100	1/2	3/6		6	80
	3/4/5	3/4/6		6	70
125	1/2	3/6		7	105
	3/4/5/6	3/4/6		7	100
150	1/2	3/6		8	130
	3/4/5/6	3/4/6		8	120
175	1/2	3/6		10	150
	3/4/5/6/8	3/4/6		10	140
200	1/2	6		12	175
	3/4/5/6/8/10	3/4/5/6		12	160
225	6/8/10	3/4/5	12	180	
250	6/8/10/12	3/4/5	15	200	
300	8/10/12	3/4/5/6	15	250	
350	10/12/15	3/4/5/6	20	300	
400	10/12/15/20	3/4/5/6	25	350	
450	10/12/15/20	3/4/5/6	25	400	
500	15/20/25	3/4/5/6	30	450	
600	15/20/25/30	3/5	35	550	

Ordering example: 14A1 150-6-3-32 D 107 PHN C 100

D [mm]	U [mm]	X [mm]	R [mm]	H [mm]	T [mm]	J [mm]
40	2	3/4/5/6	1	Please specify	6	25
	3		1.5		6	25
	4		2		6	25
50	2		1		6	30
	3		1.5		6	30
	4		2		6	30
75	2		1		6	50
	3		1.5		6	50
	4		2		6	50
100	2		1		6	70
	3		1.5		6	70
	4		2		6	70
125	2	1	8	100		
	3	1.5	8	100		
	4	2	8	100		
150	2	1	8	120		
	3	1.5	8	120		
	4	2	8	120		

Ordering example: 14F1 150-2/1R-6-32 D 107 PHN C 125

Shape 14V1

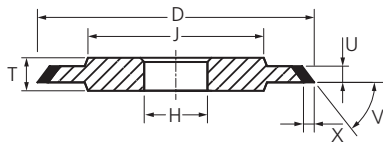

D [mm]	U [mm]	X [mm]	V	C [mm]	T [mm]	J [mm]
50	3/4/5	2/3/4	20° to 89°	Please specify	6	30
75	3/4/5				6	45
100	4/6	8	70			
125	4/6	8	100			
150	4/6	8	120			
175	4/6/8	10	140			
200	4/6/8/10	12	160			
250	4/6/8/10/12	15	200			
300	4/6/8/10/12	15	250			

Ordering example: 14V1 150-6-3/60°-32 B 126 PHN C 75

Shape 14E9

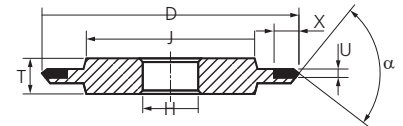

D [mm]	U [mm]	X [mm]	α	H [mm]	T [mm]	J [mm]
50	1/2	6	35°/45°/60°/90°	Please specify	6	32
75	1/2	6	35°/45°/60°/90°		6	50
100	1/2	6	35°/45°/60°/90°		6	70
125	1/2	6	35°/45°/60°/90°		8	100
150	1/2	6	35°/45°/60°/90°		8	120

Ordering example: 14E9 150-2-6-60°-32 D 107 PHN C 125

Other dimensions on request!





PFERD diamond cut-off wheels are manufactured in compliance with the highest quality and safety standards. They guarantee optimum cutting results and allow economic work on different materials, e.g. concrete, exposed aggregate concrete, clinker brick, hard stone, granite and other abrasive building materials. The product range offers the best tool for any application.

Advantages:

- High diamond qualities.
- Excellent cutting characteristics and short cutting times.
- Long tool life.
- High ease of cutting.
- High profitability.

Recommendations for use:

- If possible, wet grinding is to be preferred to dry grinding. This reduces tool wear, the risk of thermal damage to the workpiece and dust exposure.
- Cut using low pressure in order to stop the tool overheating.

Matching tool drives:

- Angle grinder
- Petrol cutter
- Table saw
- Joint cutter



Explanation of the order description

DS 230 x 2.8 x 22.23 SG

① ② ③ ④ ⑤

① Description and shape of the tool

- DS = Diamond, segmented type for fast cutting
- DG = Diamond, continuous rim type for easy cutting (TURBO)
- DG FL = Diamond, continuous rim type for very fine cutting, e.g. tiles and glazed tiles

② Outer diameter

Outer dia. D in [mm]

③ Disc width

Disc width T in [mm]

④ Bore diameter

Bore dia. H in [mm]

⑤ PFERD product line

- Universal Line PSF
- Performance Line SG

The PFERD description corresponds to the designation in accordance with EN 13236.

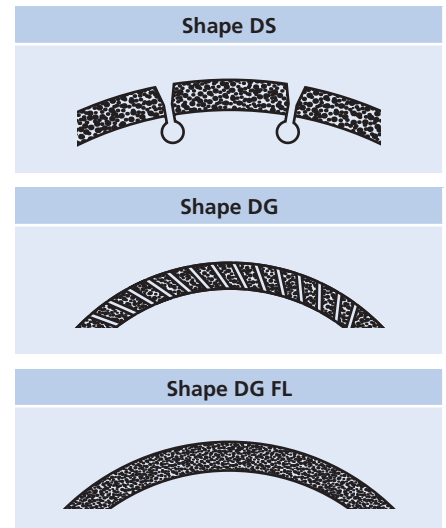

The fast way to the best tool

Application	Material	Tools	Page
Aggressive, fast cutting	<ul style="list-style-type: none"> ■ Concrete (medium-hard, reinforced, hard) ■ Aerated concrete ■ Pumice ■ Brick ■ Soft clinker brick ■ Sand-lime brick 	Cut-off wheels of the type DS PSF and SG	50
Easy cutting with high cutting quality	<ul style="list-style-type: none"> ■ Fresh concrete ■ Screed ■ Firebrick 	Cut-off wheels of the type DG SG	50
	<ul style="list-style-type: none"> ■ Sandstone ■ Clay brick ■ Slate ■ Granite ■ Marble 	Cut-off wheels of the type DG PSF and SG	51
	<ul style="list-style-type: none"> ■ Glazed tiles ■ Ceramic tiles ■ Porcelain stoneware ■ Slate ■ Marble 	Cut-off wheels of the type DG FL PSF and SG	52

Diamond cut-off wheels for the construction industry

Segmented type for fast cutting

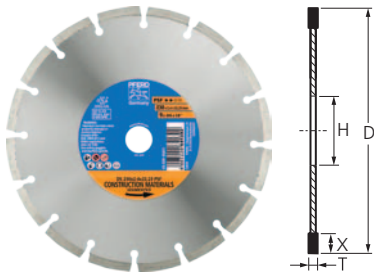

DS PSF type

Multi-purpose segmented tool for aggressive, fast cutting with high cutting performance and a long tool life.

Recommendations for use:

- Suitable for use on angle grinders of all output levels.

D [mm]	T [mm]	EAN 4007220	H [mm]	X [mm]	Max. RPM		Description
115	2.2	641361	22.23	7	13,300	1	DS 115 x 2,2 x 22,23 PSF
125	2.2	641378	22.23	7	12,200	1	DS 125 x 2,2 x 22,23 PSF
178	2.4	641385	22.23	7	8,600	1	DS 178 x 2,4 x 22,23 PSF
230	2.4	641392	22.23	7	6,600	1	DS 230 x 2,4 x 22,23 PSF

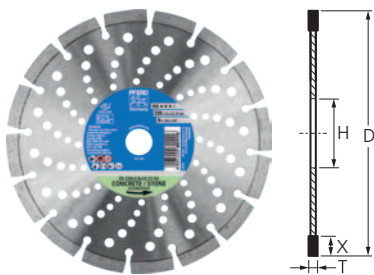

DS SG type

High-performance segmented tool for aggressive, fast cutting of hard materials with high cutting performance and very long tool life.

Recommendations for use:

- The maximum operating speed for diamond cut-off wheels DS type with a diameter of 300 to 400 mm is 100 m/s.
- Suitable for use on angle grinders of all output levels.

Ordering notes:

- All diamond cut-off wheels with a centre hole diameter of 25.4 mm are supplied with a reducing ring to 22.23 mm for use on angle grinders.

D [mm]	T [mm]	EAN 4007220	H [mm]	X [mm]	Max. RPM		Description
115	2.4	801086	22.23	10	13,300	1	DS 115 x 2,4 x 22,23 SG
125	2.4	801093	22.23	10	12,200	1	DS 125 x 2,4 x 22,23 SG
178	2.6	801109	22.23	10	8,600	1	DS 178 x 2,6 x 22,23 SG
230	2.8	801116	22.23	10	6,600	1	DS 230 x 2,8 x 22,23 SG
300	2.8	801123	20.0	10	6,400	1	DS 300 x 2,8 x 20,0 SG
		801147	25.4 (22.23)	10	6,400	1	DS 300 x 2,8 x 25,4 SG
350	2.8	801154	20.0	10	5,400	1	DS 350 x 2,8 x 20,0 SG
		801161	25.4 (22.23)	10	5,400	1	DS 350 x 2,8 x 25,4 SG
400	3.2	801178	25.4 (22.23)	10	4,800	1	DS 400 x 3,2 x 25,4 SG





DG PSF type

Multi-purpose continuous rim tool for easy cutting with high cutting performance and long tool life.

Recommendations for use:

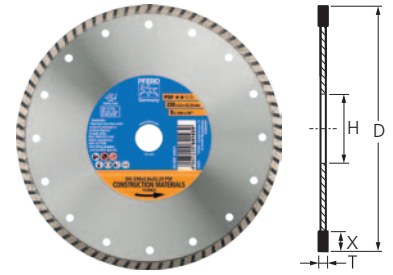
- Suitable for use on angle grinders of all output levels.



D [mm]	T [mm]	EAN 4007220	H [mm]	X [mm]	Max. RPM		Description
115	2.1	641408	22.23	7	13,300	1	DG 115 x 2,1 x 22,23 PSF
125	2.1	641415	22.23	7	12,200	1	DG 125 x 2,1 x 22,23 PSF
178	2.4	641422	22.23	7	8,600	1	DG 178 x 2,4 x 22,23 PSF
230	2.6	641439	22.23	7	6,600	1	DG 230 x 2,6 x 22,23 PSF

DG SG type

High-performance continuous rim tool for easy cutting with high cutting performance and very long tool life.

Recommendations for use:

- Suitable for use on angle grinders of all output levels.

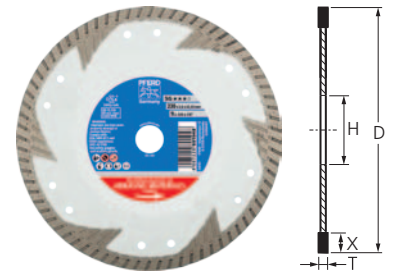

D [mm]	T [mm]	EAN 4007220	H [mm]	X [mm]	Max. RPM		Description
115	2.2	801000	22.23	8	13,300	1	DG 115 x 2,2 x 22,23 SG
125	2.2	801024	22.23	8	12,200	1	DG 125 x 2,2 x 22,23 SG
178	2.5	801031	22.23	8	8,600	1	DG 178 x 2,5 x 22,23 SG
230	2.8	801048	22.23	8	6,600	1	DG 230 x 2,8 x 22,23 SG



Diamond cut-off wheels for the construction industry

Continuous rim type for very fine cutting

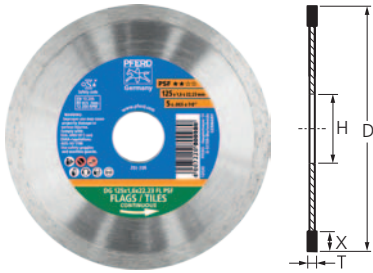

DG FL PSF type

Multi-purpose continuous rim tool for cutting without edge breakages on workpieces with high-quality surfaces. High cutting performance and long tool life.

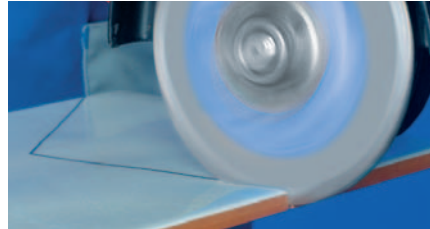

Recommendations for use:

- Suitable for use on angle grinders of all output levels.

D [mm]	T [mm]	EAN 4007220	H [mm]	X [mm]	Max. RPM		Description
115	1.6	800973	22.23	7	13,300	1	DG 115 x 1,6 x 22,23 FL PSF
125	1.6	800980	22.23	7	12,200	1	DG 125 x 1,6 x 22,23 FL PSF

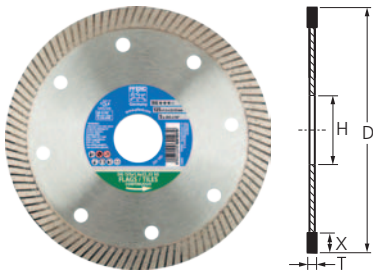

DG FL SG type

High-performance continuous rim tool for cutting without edge breakages on workpieces with high-quality surfaces. High cutting performance and very long tool life.



Recommendations for use:

- Suitable for use on angle grinders of all output levels.

D [mm]	T [mm]	EAN 4007220	H [mm]	X [mm]	Max. RPM		Description
115	1.4	801055	22.23	8	13,300	1	DG 115 x 1,4 x 22,23 FL SG
125	1.4	801079	22.23	8	12,200	1	DG 125 x 1,4 x 22,23 FL SG

Sharpening block



Sharpening block DSB

The sharpening block is used to resharpen metal-bonded diamond cut-off wheels (e.g. after cutting lubricating materials).

Type:

Silicon carbide abrasive, soft polyurethane bond

Recommendations for use:

- Cutting off thin slices of the sharpening block quickly restores the sharpness of your grinding disc.

L [mm]	B [mm]	H [mm]	Grit size		Description
			80		
			EAN 4007220		
200	50	25	168332	1	DSB 2005025