

OPERATORS MANUAL



MIGOMAG 140MMAs INVERTER



**MIGOMAG MMA / DC TIG WELDER
PART NUMBER: MOM140VRD**

THANK YOU FOR YOUR BUSINESS!

Congratulations on your new MIGOMAG MACHINE. We are proud to have you as our customer and will strive to provide you with the best service and reliability in the welding industry. This product is backed by our extensive warranty.

To locate your nearest distributor or repair agent please call +03 9313 3100, or visit us on the web at www.migomag.com.au.

This Operating Manual has been designed to instruct you on the correct use and operation of your Migomag Welder. Your satisfaction with this product and its safe operation is our ultimate concern. Therefore please take the time to read the entire manual, especially the Safety Precautions. They will help you to avoid potential hazards that may exist when working with this product.

Migomag your Welding Industrial Specialist - we are the right choice for all your welding needs.

Migomag is one of the Market Leaders of Arc Welding Products for welders needs from Light Industrial to Heavy industrial.

MIGOMAG WELDING SUPPLIES YOUR WELDING INDUSTRIAL SPECIALIST

668 SOMERVILLE ROAD,
SUNSHINE VIC 3020

03 9313 3100

info@migomag.com.au

www.migomag.com.au

A DIVISION OF WESFARMERS INDUSTRIAL & SAFETY



Record the following information for Warranty purposes:

Where Purchased: _____

Purchase Date: _____

Equipment Serial #: _____

TABLE OF CONTENTS

GENERAL SAFETY RULES	1
RECEIVING	7
DESCRIPTION	7
UNPACKING	7
SPECIFICATIONS	8
KNOW YOUR WELDER	9
FRONT CONTROL PANEL	10
INSTALLATION	11
OPERATION	14
TROUBLESHOOTING CHART	20
MAIN CIRCUIT DIAGRAM	21
MAINTENANCE, TRANSPORTATION AND STORAGE	22
SPARE PART DIAGRAM	22
SPARE PART LIST	23
HAZARD WARNINGS	24
WARRANTY	24
TERMS & CONDITIONS	25

GENERAL SAFETY RULES

WARNING! Read and understand all instructions. Failure to follow all instructions listed below may result in serious injury.

CAUTION! Do not allow persons to operate or assemble this 140 MMA until they have read this manual and have developed a thorough understanding of how the 140 MMA works.

WARNING! The warnings, cautions, and instructions discussed in this instruction manual cannot cover all possible conditions or situations that could occur. It must be understood by the operator that common sense and caution are factors which cannot be built into this product, but must be supplied by the operator.

1. YOUR WELDING ENVIRONMENT

- The welding machine is not suitable for use in rain
- Keep the environment you will be welding in free from flammable materials
- Always keep a fire extinguisher accessible to your welding environment
- Always have a qualified person install and operate this equipment
- Make sure the area is clean, dry and ventilated. Do not operate the welder in humid, wet or poorly ventilated areas
- Always have your welder maintained by a qualified technician in accordance with local, state and national codes
- Always be aware of your work environment. Be sure to keep other people, especially children, away from you while welding
- Keep harmful arc rays shielded from the view of others
- Mount the welder on a secure bench or cart that will keep the welder secure and prevent it from tipping over or falling

2. YOUR WELDER'S CONDITION

- Check ground cable, power cord and welding cable to be sure the insulation is not damaged. Always replace or repair damaged components before using the welder
- Check all components to ensure they are clean and in good operating condition before use

3. USE OF YOUR WELDER

CAUTION! Do not operate the welder if the output cable, electrode, torch, wire or wire feed system is wet. Do not immerse them in water. These components and the welder must be completely dry before attempting to use them.

- Follow the instructions in this manual
- Keep welder in the off position when not in use
- Connect ground lead as close to the area being welded as possible to ensure a good ground
- Do not allow any body part to come in contact with the welding wire if you are in contact with the material being welded, ground or electrode from another welder
- Do not weld if you are in an awkward position. Always have a secure stance while welding to prevent accidents. Wear a safety harness if working above ground
- Do not drape cables over or around your body
- Wear a full coverage helmet with appropriate shade (see ANSI Z87.1 safety standard) and safety glasses while welding
- Wear proper gloves and protective clothing to prevent your skin from being exposed to hot metals, UV and IR rays
- Do not overuse or overheat your welder. Allow proper cooling time between duty cycles
- Keep hands and fingers away from moving parts and stay away from the drive rolls
- Do not point torch at any body part of yourself or anyone else
- Always use this welder in the rated duty cycle to prevent excessive heat and failure



4. SPECIFIC AREAS OF DANGER, CAUTION OR WARNING

ELECTRICAL SHOCK

WARNING! Electric arc welders can produce a shock that can cause injury or death. Touching electrically live parts can cause fatal shocks and severe burns. While welding, all metal components connected to the wire are electrically hot. Poor ground connections are a hazard, so secure the ground lead before welding.

- Wear dry protective apparel: coat, shirt, gloves and insulated footwear
- Insulate yourself from the work piece. Avoid contacting the work piece or ground
- Do not attempt to repair or maintain the welder while the power is on
- Inspect all cables and cords for any exposed wire and replace immediately if found

- Use only recommended replacement cables and cords
- Always attach ground clamp to the work piece or work table as close to the weld area as possible
- Do not touch the welding wire and the ground or grounded work piece at the same time
- Do not use a welder to thaw frozen pipes



FUMES AND GASES - WARNING!

- Fumes emitted from the welding process displace clean air and can result in injury or death
- Do not breathe in fumes emitted by the welding process. Make sure your breathing air is clean and safe
- Work only in a well-ventilated area or use a ventilation device to remove welding fumes from the environment where you will be working
- Do not weld on coated materials (galvanized, cadmium plated or containing zinc, mercury or barium). They will emit harmful fumes that are dangerous to breathe. If necessary use a ventilator, respirator with air supply or remove the coating from the material in the weld area
- The fumes emitted from some metals when heated are extremely toxic. Refer to the material safety data sheet for the manufacturer's instructions
- Do not weld near materials that will emit toxic fumes when heated. Vapors from cleaners, sprays and degreasers can be highly toxic when heated



UV AND IR ARC RAYS

DANGER! The welding arc produces ultraviolet (UV) and infrared (IR) rays that can cause injury to your eyes and skin. Do not look at the welding arc without proper eye protection.

- Always use a helmet that covers your full face from the neck to top of head and to the back of each ear
- Use a lens that meets ANSI standards and safety glasses. For welders under 160 Amps output, use a shade 10 lens; for above 160 Amps, use a shade 12. Refer to the ANSI standard Z87.1 for more information

- Cover all bare skin areas exposed to the arc with protective clothing and shoes. Flame-retardant cloth or leather shirts, coats, pants or coveralls are available for protection
- Use screens or other barriers to protect other people from the arc rays emitted from your welding
- Warn people in your welding area when you are going to strike an arc so they can protect themselves



FIRE HAZARDS

WARNING! Do not weld on containers or pipes that contain or have had flammable, gaseous or liquid combustibles in them. Welding creates sparks and heat that can ignite flammable and explosive materials.

- Do not operate any electric arc welder in areas where flammable or explosive materials are present
- Remove all flammable materials within 35 feet of the welding arc. If removal is not possible, tightly cover them with fireproof covers
- Take precautions to ensure that flying sparks do not cause fires or explosions in hidden areas, cracks or areas you cannot see
- Keep a fire extinguisher close in the case of fire
- Wear garments that are oil-free with no pockets or cuffs that will collect sparks
- Do not have on you any items that are combustible, such as lighters or matches
- Keep work lead connected as close to the weld area as possible to prevent any unknown, unintended paths of electrical current from causing electrical shock and fire hazards
- To prevent any unintended arcs, cut wire back to ¼" stick out after welding



HOT MATERIALS

CAUTION! Welded materials are hot and can cause severe burns if handled improperly.

- Do not touch welded materials with bare hands
- Do not touch TIG gun nozzle after welding until it has had time to cool down



SPARKS/FLYING DEBRIS

CAUTION! Welding creates hot sparks that can cause injury. Chipping slag off welds creates flying debris.

- Wear protective apparel at all times: ANSI-approved safety glasses or shield, welder's hat and ear plugs to keep sparks out of ears and hair.



ELECTROMAGNETIC FIELD - CAUTION!

- Electromagnetic fields can interfere with various electrical and electronic devices such as pacemakers
- Consult your doctor before using any electric arc welder or cutting device
- Keep people with pacemakers away from your welding area when welding
- Do not wrap cable around your body while welding
- Wrap TIG gun and ground cable together whenever possible
- Keep TIG gun and ground cables on the same side of your body

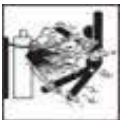

SHIELDING GAS CYLINDERS CAN EXPLODE

WARNING! High pressure cylinders can explode if damaged, so treat them carefully.

- Never expose cylinders to high heat, sparks, open flames, mechanical shocks or arcs
- Do not touch cylinder with TIG gun
- Do not weld on the cylinder
- Always secure cylinder upright to a cart or stationary object
- Keep cylinders away from welding or electrical circuits
- Use the proper regulators, gas hose and fittings for the specific application

- Do not look into the valve when opening it
- Use protective cylinder cap whenever possible

5. PROPER CARE, MAINTENANCE AND REPAIR

- Always have power disconnected when working on internal components
- Do not touch or handle PC board without being properly grounded with a wrist strap. Put PC board in static proof bag to move or ship
- Do not put hands or fingers near moving parts such as drive rolls of fan

MOM 140 MMA USE AND CARE

- **Do not modify the MOM 140 MMA in any way.** Unauthorized modification may impair the function and/or safety and could affect the life of the equipment. There are specific applications for which the **MOM 140 MMA** was designed
- **Always check of damaged or worn out parts before using the MOM 140 MMA.** Broken parts will affect the **MOM 140 MMA** operation. Replace or repair damaged or worn parts immediately
- **Store idle MOM 140 MMA.** When **MOM 140 MMA** is not in use, store it in a secure place out of the reach of children. Inspect it for good working condition prior to storage and before re-use

NOTICE:

- If the welder continues to work for too long, the (Protection Indicator) on the panel would be on, indicating that the inner temperature rise inside the welder had exceeded the designed permitted temperature. At this time, stop the welding work, wait until the welder has cooled inside and the (Protection Indicator) has turned off, then continue to work again
- Cut off the power switch and gas cylinder, before leaving the welding place temporarily or after the welding work is finished
- Welders should wear canvas work clothes and welding face shield to prevent arc light and heat radiation
- Put light-proof screen around the work area to prevent others influenced by the arc lights
- Flammable, explosive items could not be put near the welding area
- Every outlet of the welder should be connected and earthed correctly

NOTICE: The cover protection degree of the MOM series 140 MMA welder is IP21S. When the welder is operated, do not insert finger or round stick diameter less than 12.5mm (especially metal stick) into the welder; Do not allow to press heavily onto the welder.

RECEIVING

Check the equipment received against the shipping invoice to make sure the shipment is complete and undamaged. If any damage has occurred in transit, please immediately notify your supplier.

The Migomag MMA inverter package contains;

- MIGOMAG Inverter Power Source
- Twist-lock Electrode Holder lead 2MT
- Work Clamp 2MT
- (This) Operating Manual AAM140

Optionally available:

- TIG Torch Complete MM17FVXSM with valve, 3m cable with dinse conector connection and fitted with 2.4mm collet and tungsten
- Argon regulator CZ101-327

Please read through this owner's manual carefully before using product. Protect yourself and others by observing all safety information, warnings, and cautions. Failure to comply with instructions could result in personal injury and/or damage to product or property. Please retain these instructions for future reference.

DESCRIPTION

The MMA series is a DC inverter MMA welder . This unit uses 1~Phase 240V, 50/60HZ AC power. The MMA series is ideal for Do-It-Yourself projects or for light maintenance. Stick welding carbon steel, stainless steel.

UNPACKING

1. Remove cartons, bags or Styrofoam containing the welder machine and accessories. Check the contents with the packing list below.

ITEM	QTY.
DC INVERTER ARC WELDER MOM 140	1 UNIT
WELDING CABLE WITH ELECTRODE HOLDER 3MT	1 PC
GROUNDING CABLE WITH EARTH CLAMP 3MT	1 PC
OPERATOR'S MANUAL	1 SET

2. After unpacking unit, inspect carefully for any damage that may have occurred during transit. Check for loose, missing, or damaged parts. Shipping damage claim must be filed with carrier.

SPECIFICATIONS

Manufactured to Australian Standard
AS60974-1: 2006
AS610003.3

Primary Voltage

240 Volts 50/60 HZ

Rated Primary Current (I eff)

10Amp

Maximum Primary Current (I max)

26Amp

Recommended Generator kVA

7.0 kVA

Rated Output 15% @ 40 Deg

Duty cycle based on 10 minute cycle time

RATING IP21S

MMA/Stick

Model MOM MMA140

140 Amp, 25.6 V, 15% duty

70 Amp, 22.8 V, 60% duty

54 Amp, 22.5 V, 100% duty

TIG

Model MOM MMA140

140 Amp, 15.6 V, 15% duty

70 Amp, 12.8 V, 60% duty

54 Amp, 12.2 V, 100% duty

Welding Current

20-140 amps on 140 MMA

Open Circuit Voltage

98 V without VRD

13.5 V with VRD

Mains Circuit Breaker Rating

26 Amp

Supply plug

10 Amp

Fitted Supply Cable

1.5 mm² Three Core, Heavy Duty PVC

Cooling

Fan cooled, air drawn in through back of machine

Insulation

Class H, 140°C Rise

Rods sizes

MOM 140 MMA 1.6mm to 3.2mm

If the supply cable is damaged it must be replaced by the manufacturer, their service agent or a similarly qualified person

Power Supply Outlet (240 V) & Extension Lead Rating

10 Amp

Dimension (mm) H x W x L

355 X 255 X 470

Weight

Package 9.5kg

Machine 5.5kg

KNOW YOUR WELDER

Factory standard: EN60974-1

Optional Accessories: Tig torch and regulator



1. POWER SWITCH - When switch is in "OFF" position no power is being supplied. When the switch is in the "ON" position power is supplied to the machine
2. INPUT POWER LEAD - Primary input lead that will need to be connected to 240v 10Amp supply 50/60hz
3. MACHINE
4. EARTH CABLE - The earth cable is attached to the work piece to complete the circuit, allowing the flow of current needed to weld
5. WELDING CABLE - The welding cable is attached to electrode to complete the circuit, allowing the flow of current needed to do weld
6. MACHINE CONTROL PANEL - For controls see page 11
7. CARRY HANDLE/STRAP - Machine comes with strap for carrying machine

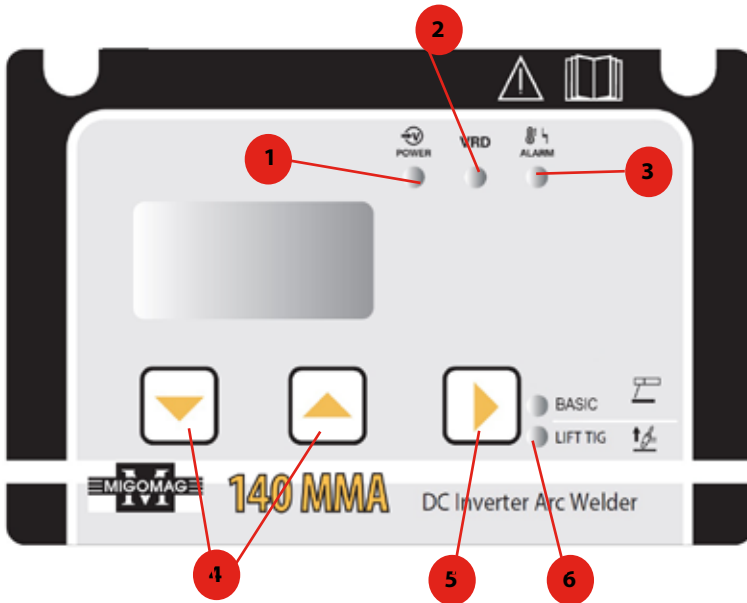

FRONT CONTROL PANEL

1. POWER INDICATOR - When the machine is turned on, the power indicator will be on
2. VRD INDICATOR - When the machine is turned on, the power indicator will be on
3. ALARM INDICATOR - When the thermal indicator is on, it shows the machine is overloaded and the internal temperature is too high. Weld output will turn off automatically but the fan will still be working. When the internal temperature is decreased, the overload light will turn off and the machine will be ready to weld
4. WELDING CURRENT - Welding Current adjustment is on the front panel of machine. It is an infinite current output adjustment. The ground cable/clamp are attached to the work piece to complete the circuit, allowing the flow of current needed to weld
5. WELD MODE SELECTION
6. WELDING MODE INDICATOR - You can select MMA, selection and scratch start DC Tig welding. Optional tig torch is required

INSTALLATION

1. POWER REQUIREMENT

AC single phase 240V, 50/60HZ fused with a 25 amp time delayed fuse or 25amp circuit breaker is required.

WARNING:

- The equipment class of MMA series DC Inverter Arc Welder is class A.
- MMA series DC Inverter Arc Welder adopt the drooping characteristic.
- High voltage danger from power source! Consult a qualified electrician for proper installation of receptacle. This welder must be grounded while in use to protect the operator from electrical shock.
- Do not remove grounding prong or alter the plug in any way. Do not use any adapters between the welder's power cord and the power source receptacle. Make sure the POWER switch is OFF when connecting your welder's power cord to a properly grounded 240Vac, 50/60Hz, single phase.

2. EXTENSION CORD

DURING NORMAL USE AN EXTENSION CORD IS NOT NECESSARY. IT IS RECOMMENDED THAT IF AN EXTENSION CORD IS TO BE USED IT MUST BE A 10 AMP CORD WITH 2.5MM AT A MINIMUM.

THE MAXIMUM EXTENSION CORD LENGTH MUST NOT EXCEED 15 FT. IN LENGTH.

3. SETTING UP THE WORK PIECE

3.1 WELDING POSITIONS

There are two basic positions, for welding: Flat and Horizontal. Flat welding is generally easier, faster, and allows for better penetration. If possible, the work piece should be positioned so that the bead will run on a flat surface.

3.2 PREPARING THE JOINT

Before welding, the surface of work piece needs to be free of dirt, rust, scale, oil or paint. Or it will create brittle and porous weld. If the base metal pieces to be joined are thick or heavy, it may be necessary to bevel the edges with a metal grinder. The correct bevel should be around 60 degrees.

See following picture:

Based on different welding positions, there are different welding joints, see following images for more information.

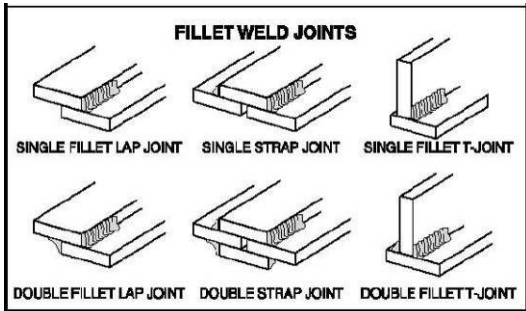
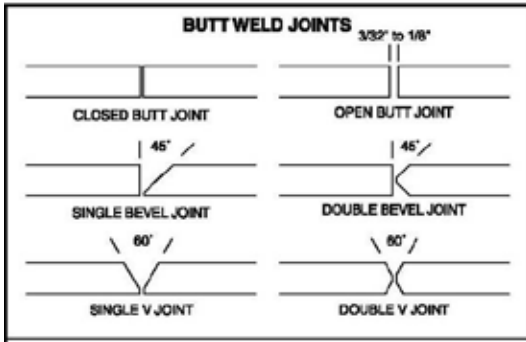

4. GROUND CLAMP CONNECTION

Clear any dirt, rust, scale, oil or paint on the ground clamp. Make certain you have a good solid ground connection. A poor connection at the ground clamp will waste power and heat. Make sure the ground clamp touches the metal.

5. ELECTRODE

The welding electrode is a rod coated with a layer of flux. When welding, electrical current flows between the electrode (rod) and the grounded metal work piece. The intense heat of the arc between the rod and the grounded metal melts the electrode and the flux. The most popular electrodes are:

- **Kobe -6010** E6010 tensile strength deep penetrating applications.
- **Kobe RB-26** E6013 tensile strength used for poor fit up applications
- **Kobe LB-52U** E7016 tensile strength used for high deposition and fast travel speeds with light penetration
- **Kobe LB-52-18** E7018 70,000 PSI tensile strength, Used for out of position and tacking.

6. SELECTING THE PROPER ELECTRODE

There is no golden rule that determine the exact rod or heat setting required for every situation. The type and thickness of metal and the position of the work piece determine the electrode type and the amount of heat needed in the welding process. Heavier and thicker metals required more amperage. It is best to practice your welds on scrap metal which matches the metal you intend to work with to determine correct heat setting and electrode choice. See following some helpful trouble shooting tips to determine if you are using a correct electrode.

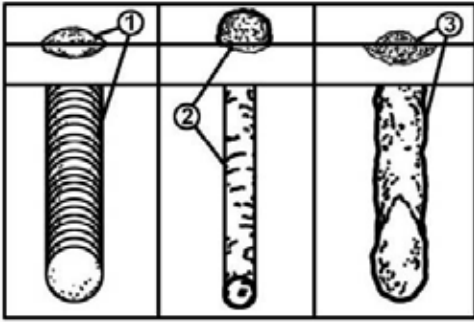

1. When proper rod is used:
 - a. The bead will lay smoothly over the work without ragged edges
 - b. The base metal puddle will be as deep as the bead that rises above it
 - c. The welding operation will make a crackling sound

2. When a rod too small is used
 - a. The bead will be high and irregular
 - b. The arc will be difficult to maintain

3. When the rod is too large
 - a. The arc will burn through light metals
 - b. The bead will undercut the work
 - c. The bead will be flat and porous
 - d. Rod may be freeze or stick to work piece

Note: Rate of travel over the work also affects the weld. To ensure proper penetration and enough deposit of rod, the arc must be moved slowly and evenly along the weld seam.

OPERATION

1.SETTING THE AMPERAGE CONTROL

The welder has an infinite output current control. It is capable of welding with 1.6m, 2.6m and 3.2m.

There is no golden rule that determines the exact amperage required for every situation. It is best to practice your welds on scrap metal which matches the metals you intend to work with to determine correct setting for your job. The electrode type and the thickness of the work piece metal determine the amount of heat needed in the welding process. Heavier and thicker metals require more voltage (amperage), whereas lighter and thinner metals require less voltage (amperage).

2.WELDING TECHNIQUES

The best way to teach yourself how to weld is with short periods of practice at regular intervals. All practice welds should be done on scrap metal that can be discarded. Do not attempt to make any repairs on valuable equipment until you have satisfied yourself that your practice welds are of good appearance and free of slag or gas inclusions.

2.1 HOLDING THE ELECTRODE

The best way to grip the electrode holder is the way that feels most comfortable to you. To Position the Electrode to the work piece when striking the initial arc it may be necessary to hold the electrode perpendicular to the work piece. Once the arc is started the angle of the electrode in relation to the work piece should be between 10 and 30 degrees. This will allow for good penetration, with minimal spatter.

2.2 STRIKING THE ARC

WARNING!

EXPOSURE TO A WELDING ARC IS EXTREMELY HARMFUL TO THE EYES AND SKIN.

- Never strike an arc or begin welding until you have adequate protection.
- Wear flameproof welding gloves, heavy long-sleeved shirt, cuffless trousers, high-topped shoes and a welding helmet or shield.

Scratch the work piece with the end of electrode to start arc and then raise it quickly about 1/8 inch gap between the rod and the work piece. See following picture

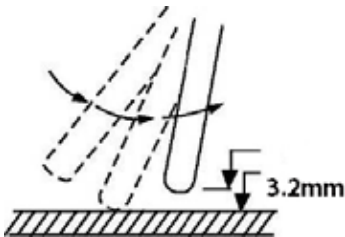

It is important that the gap be maintained during the welding process and it should be neither too wide or too narrow. If too narrow, the rod will stick to the work piece. If too wide, the arc will be extinguished. It needs much practice to maintain the gap. Beginners may usually get sticking or arc extinguishing. When the rod sticks to the work piece, gently rock it back and forth to make them separate. If not, the circuit is short connection, and it will overload the welder. A good arc is accompanied by a crisp, cracking sound. The sound is similar to that made by eggs frying. To lay a weld bead, only 2 movements are required; downward and in the direction the weld is to be laid, as in following figure:

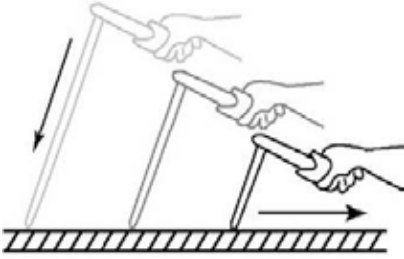

2.3 TYPES OF WELD BEAD

The following paragraphs discuss the most commonly used arc welding beads.

The stringer bead Formed by traveling with the electrode in a straight line while keeping it centered over the weld joint.

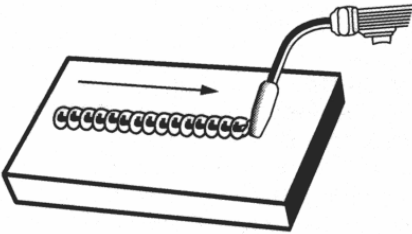

The weave bead used when you want to deposit metal over a wider space than would be possible with a stringer bead. It is made by weaving from side to side while moving with the electrode. It is best to hesitate momentarily at each side before weaving back the other way to improve penetration.

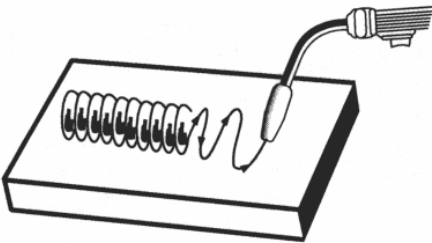

2.4 WELDING POSITION

Flat position is the easiest of the welding positions and is most commonly used. It is best if you can weld in the flat position if at all possible as good results are easier to achieve.

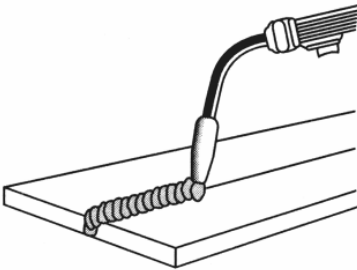

The horizontal position is performed very much the same as the flat weld except that the angle is different such that the electrode, and therefore the arc force, is directed more toward the metal above the weld joint. This more direct angle helps prevent the weld puddle from running downward while still allowing slow enough travel speed to achieve good penetration. A good starting point for your electrode angle is about 30 degrees DOWN from being perpendicular to the work piece.



2.5 JUDGE A GOOD WELD BEAD

When the trick of establishing and holding an arc has been learned, the next step is learning how to run a good bead. The first attempts in practice will probably fall short of acceptable weld beads. Too long of an arc will be held or the travel speed will vary from slow to fast (see following).

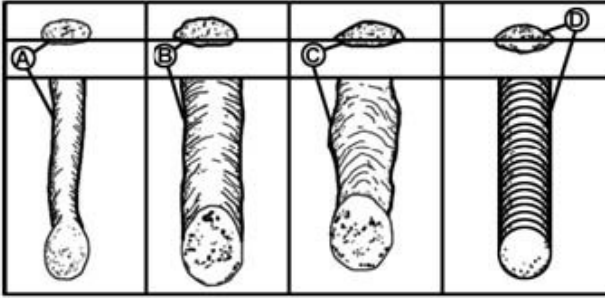

- A. Weld speed is too fast
- B. Weld speed is too slow
- C. Arc is too long
- D. Ideal weld

A solid weld bead requires that the electrode be moved slowly and steadily along the weld seam. Moving the electrode rapidly or erratically will prevent proper fusion or create a lumpy, uneven bead. To prevent ELECTRIC SHOCK, do not perform any welding while standing, kneeling, or lying directly on the grounded work.

2.6 FINISH THE BEAD

As the coating on the outside of the electrode burns off, it forms an envelope of protective gasses around the weld. This prevents air from reaching the molten metal and creating an undesirable chemical reaction. The burning coating, however, forms slag. The slag formation appears as an accumulation of dirty metal scale on the finished weld. Slag should be removed by striking the weld with a chipping hammer.

3. TIG

3.1 ACCESSORIES

Turn off the power source. Connect the ground cable to the positive electrode and do it up tighter, connect the end of the ground cable to the work piece. Connect the torch cable to the - negative and do it up tight, the gas fittings on dinse which connects the gas hose. It connects to the gas cylinder.

3.2 THE SCRATCH START

Warning! Turn on the power source, Welding torch's tungstic electrode already charged. The tungstic electrode can not touch anything. This series welding machine TIG weld uses contact striking the arc way; Striking the arc method in following step:

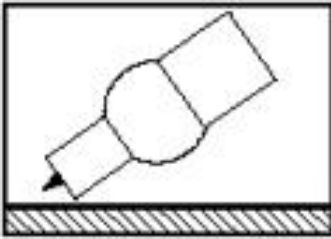

A. Turn on the welding torch gas valve. Approach the striking the arc spot the spray nozzle to cause the tungstic electrode and the work piece is separated 2~3mm.

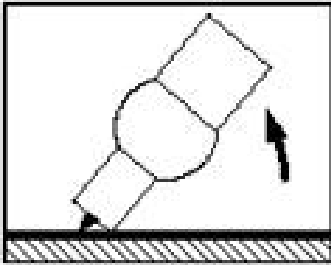

B. Slowly lifts the welding torch to cause the tungsten electrode contact work piece.

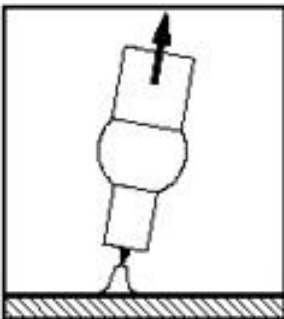

C. Lifts the welding torch to the normal position, starts to weld.

TROUBLESHOOTING CHART

NO	BREAKDOWN	ANALYSIS	SOLUTIONS
1	Yellow Indicator is on	Voltage is too high ($\geq 15\%$)	Switch off power source; Check the main supply; Restart welder when power recovers to normal state.
		Voltage is too low ($\leq 15\%$)	
		Bad power ventilation lead to over-heat protection	Improve the ventilation condition.
		Circumstance temperature is too high.	It will automatically recover when the temperature low down.
		Using over the rated duty-cycle.	It will automatically recover when the temperature low down.
2	Cooling Fan not working or turning very slowly	Switch broken	Replace the switch
		Fan broken	Replace or repair the fan
		Wire broken or falling off	Check the connection
3	Arc is not stable and splash is large	Too large contact tip makes the current unsteady	Change the proper contact tip or roller
		Too thin power cable makes the power astaticism	Change the power cable
		Too low input voltage	Enhance the input voltage

MAIN CIRCUIT DIAGRAM

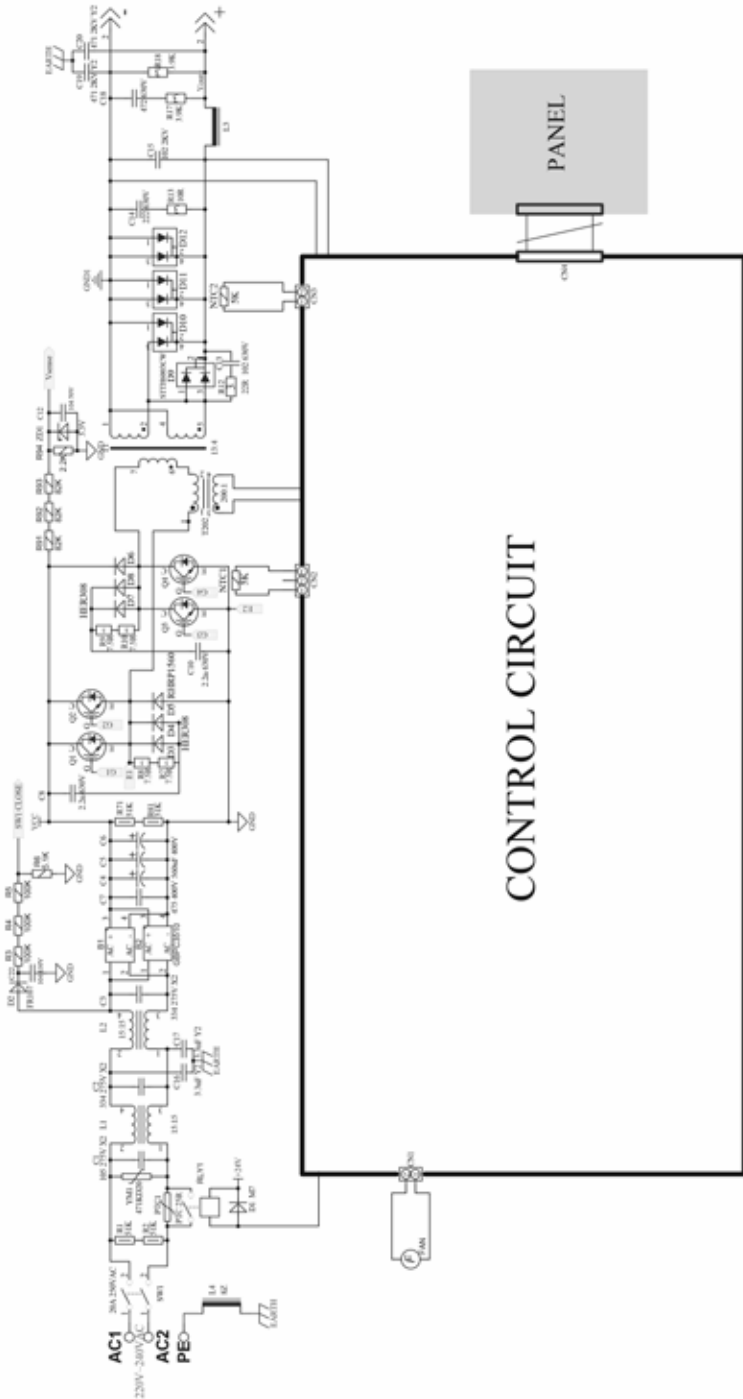

MAINTENANCE, TRANSPORTATION AND STORAGE

The welder needs regular maintenance as following: Periodically clean dust, dirt, grease, etc. from your welder. Every six months, or as necessary, remove the cover panel from the welder and air-blow any dust and dirt that may have accumulated inside the welder. Replace power cord, ground cable, ground clamp, or electrode assembly when damaged or worn.

Minor and Routine Maintenance

Store in a clean dry facility free from corrosive gas, excess dust and high humidity.

Temperature range from 10F120°F and the relative humidity not more than 90%.

When transporting or storing the welder after use, it is recommended to repack the product as it was received for protection. Cleaning is required before storage and you must seal the plastic bag in the box for storage.

SPARE PART DIAGRAM

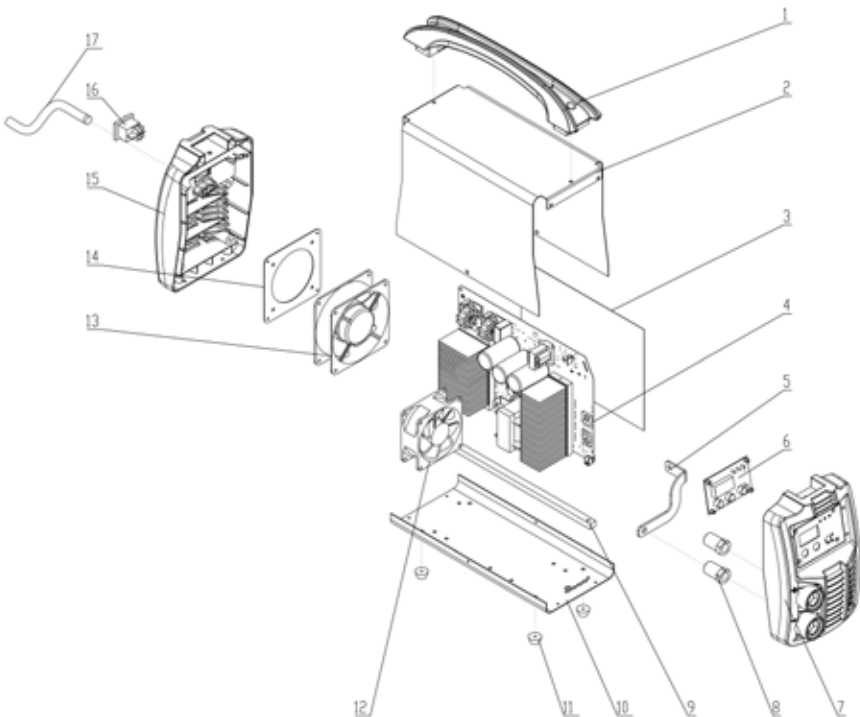

SPARE PART LIST

NO	PART NUMBER	DESCRIPTION	QTY/ UNIT
1	88002000	HANDLE	1
2	88002001	BODY PANEL	1
3	88001001	INSULATION SHEET FOR MAIN PCB	1
4	88000999	MAIN CONTROL PCB	1
5	88002003	COPPER BUZZBAR	1
6	88000998	FRONT CONTROL PCB	1
7	88002004	PLASTIC FRONT PANEL	1
8	88002005	PANEL MOUNT DINSE CONNECTOR	1
9	88002006	BOTTOM FRAME	1
10	88002007	BOTTOM FRAME PANEL PLATE	1
11	88002008	RUBBER FEET	1
12	88000997	COOLING FAN	1
13	88002011	MAIN COOLING FAN	1
14	88002012	COOLING FAN BRACKET	1
15	88002013	REAR PLASTIC COVER PANEL	1
16	88002014	MAIN SWITCH	1
17	88002020	PRIMARY INPUT LEAD	1
NO IMAGE	88002018	3M* 16MM2 EARTH LEAD WITH THE CLAMP AND DINSE CONNECTOR	1
NO IMAGE	88002019	3M* 16MM2 WELDING CABLE WITH ELECTRODE HOLDER AND DINSE CONNECTOR	1

HAZARD WARNINGS

 <h1>WARNING</h1> <p>Do Not Remove, Destroy, Or Cover This Label.</p>		 <h3>FIRE HAZARDS</h3> <ul style="list-style-type: none"> Remove all flammable materials within 35 feet of the welding arc Keep flying sparks from entering cracks or hidden areas Keep a fire extinguisher close Wear oil-free garments without pockets or cuffs Do not weld on closed containers
 <h3>ELECTRIC SHOCK can kill</h3> <ul style="list-style-type: none"> Wear dry protective apparel Avoid contacting work piece or ground Avoid contact with electrically live parts Do not touch work piece and welding wire at the same time Use only recommended cables and cords Connect ground clamp as close to the welding area as possible Disconnect power when servicing this welder 	 <h3>ARC RAYS</h3> <ul style="list-style-type: none"> Always wear a helmet with full face and neck protection with shade #10 lens Use helmet that meets ANSI standards Cover exposed skin with proper clothing Warn people in the welding area when you are starting an arc 	
 <h3>FUMES AND GASES</h3> <ul style="list-style-type: none"> Do not breathe fumes emitted by the welding process Work in a well ventilated area Do not weld coated or plated materials (galvanized, cadmium, zinc, mercury, barium) Use ventilator when necessary Know the danger of materials you are welding Refer to MSDS sheets for welding wire and materials being welded 	 <h3>HOT MATERIALS</h3> <ul style="list-style-type: none"> Do not touch welded materials with your bare hand Do not touch MIG gun nozzle after welding 	
<p>Read the operator's manual for more safety information. For more safety information contact Migomag on (03) 9313 3100 668 Somerville Road, Sunshine VIC 3020</p>		 <h3>MAGNETIC FIELDS</h3> <ul style="list-style-type: none"> Keep people with pace makers away from your welding area Keep MIG gun and ground cables on the same side of your body Do not wrap cable around your body while welding

WARRANTY

POWER SOURCE	WARRANTY PERIOD	LABOUR
Power source only	3 Years	2 Years
ACCESSORIES	WARRANTY PERIOD	
TIG torch, electrode holder lead, earth lead, gas hose, regulator and any other accessories	6 Months	
TIG torch consumable items	NIL	

MIGOMAG WELDING MACHINES

3 Year Warranty Statement Migomag warrants to the original retail purchaser that the welding machine purchased (Product) will be free from defects in materials and workmanship for a period of 3 years from the date of purchase of the Product by the user. If a defect in material or workmanship becomes evident during that period, Migomag will, at its option, either:

- Repair the Product or pay for the cost to repair the product
- Replace the Product

In the event of such a defect, the customer should return the Product to the original place of purchase, with proof of purchase, or contact Migomag on 03 9313 3100 to locate an authorised service agent.

Any handling and transportation costs (and other expenses) incurred in claiming under this warranty are not covered by this warranty and will not be covered by Migomag.

TERMS & CONDITIONS

WARRANTY AND LIABILITY OF SELLER

(a) The Seller makes no express warranties under this Agreement. Manufacturers of goods may, from time to time, provide a voluntary warranty directly to the Buyer in relation to goods supplied to the Buyer. The Buyer must address issues relating to a manufacturer's warranty with the manufacturer on the terms of that warranty.

(b) Buyer shall immediately notify the Seller in writing of any defect in the goods supplied by the Seller. The Buyer shall not carry out any remedial work to allegedly defective goods without first obtaining the written consent of that Seller to do so. The provisions of this clause 21(b) do not constitute a warranty in relation to the quality or fitness of the goods, or require the Seller to repair or replace goods, or offer a refund in relation to goods, in circumstances other those set out in Australian Consumer Law (to the extent that the Australian Consumer Law applies to the goods).

(c) The Competition and Consumer Act 2010 (Cth) and the Australian Consumer Law guarantee certain conditions, warranties and undertakings, and give you other legal rights, in relation to the quality and fitness for purpose of consumer goods sold in Australia. These guarantees cannot be modified nor excluded by any contract. Nothing in these terms and conditions purports to modify or exclude the conditions, warranties, guarantees and undertakings, and other legal rights, under the Australian Consumer Law and other laws which cannot be modified or excluded. Except as expressly set out in this Agreement and the Australian Consumer Law, the Seller makes no warranties or other representations under this Agreement. The Seller's liability in respect of these warranties, representations, undertakings and guarantees is limited to the fullest extent permitted by law.

(d) Without limiting clause 21(c), where the Seller sells goods to the Buyer, and the Buyer purchases them as a Consumer, then the Australian Consumer Law provides certain guarantees in relation to the goods. The rights of the Buyer buying goods as a Consumer include those set out in clause 21(e).

(e) Our goods come with guarantees that cannot be excluded under the Australian Consumer Law. You are entitled to a replacement or refund for a major failure and for compensation for any other reasonably foreseeable loss or damage. You are also entitled to have the goods repaired or replaced if the goods fail to be of acceptable quality and the failure does not amount to a major failure.

(f) To the extent permitted by statute, the liability, if any, of the Seller arising from the breach of any implied conditions or warranties, or failure to comply with a statutory guarantee under the Australian Consumer Law, in relation to the supply of goods other than goods of a kind ordinarily acquired for personal, domestic or household use or consumption, shall at the Seller's option be limited to:

- (i) the replacement of the goods or resupply of the goods by the Seller, or the cost of replacement or resupply of the goods; or
- (ii) the repair of the goods, or the cost of repair of the goods.

(g) Subject to clause 21(c), the Seller shall not in any circumstances be liable to the Buyer under or in connection with this Agreement, or in negligence or any other tort or otherwise howsoever, as a result of any act or omission in the course of or in connection with the performance of this Agreement, for or in respect of any Excluded Loss.

(h) The Seller makes no express warranties in relation to the suitability for any purpose of goods or materials supplied by a Seller.

(i) To the extent permitted by statute, all warranties, conditions and guarantees (whether express, implied or applied, and whether given by the Seller, the manufacturer or a third party) and any obligation of the Seller to repair or replace any goods are void in respect of any goods which the Buyer tampers with or alters.

ALTERATION TO CONDITIONS

A Seller may, at any time and from time to time, alter these terms and conditions. Any variation to these standard terms and conditions will not apply to any contract for a specified term that incorporates a version of these standard terms and conditions released prior to the variation.

For more Terms & Conditions please visit www.migomag.com.au.

Warranty provided by:

**MIGOMAG WELDING SUPPLIES
668 SOMERVILLE ROAD, SUNSHINE VIC 3020**

**03 9313 3100
info@migomag.com.au
www.migomag.com.au**

For warranty claims please email warranty@migomag.com.au

A DIVISION OF WESFARMERS INDUSTRIAL & SAFETY

