



668 Somerville Rd
Sunshine VIC 3020
Ph 03 9313 3100
Fax 03 9312 4499

63 Douro St
Nth Geelong VIC 3215
Ph 03 5240 5600
Fax 03 5277 9836

info@migomag.com.au
www.migomag.com.au

YOUR WELDING INDUSTRIAL SPECIALISTS

OPERATING MANUAL FOR MIGOMAG COMPACT WELDING MACHINES

260

(ITEM # AAM260)

400

(ITEM # AAM400)

INDEX

FRONT COVER	1
INDEX.....	2
INTRODUCTION	3
ASSEMBLY INSTRUCTIONS	3
SETTING UP FOR OPERATION	3
MACHINE CONTROLS.....	4
SHEILDING GAS	4
WORK ENVIRONMENT.....	4
OPERATION	5
SETTING UP GUN FOR WELDING ALUMINIUM.....	6
WELDING HINTS.....	6
WELDING FAULTS.....	7
SAFETY.....	8-9
SHEILDING GAS TABLE	10
MACHINE BREAKDOWN	11-12
WARRANTY.....	13
CONTACT DETAILS	14

INTRODUCTION

A few minutes spent reading about your new MIGOMAG MIG WELDING MACHINE will enable you to operate your machine efficiently and benefit from its many features.

ASSEMBLY INSTRUCTIONS

1. Fit the heavy-duty rubber tyred castor wheels and rear wheels to the chassis of the welder. Ensure the small lip of the cylinder tray faces the rear to enable easy lifting of the gas cylinder.
2. Install the cable liner to the welding gun cable as follows:
3. Lay the torch and liner out straight.
4. Check that the liner has no kinks in it.
5. Remove the liner positioning nut at the machine end of the torch.
6. Remove nozzle, tip and nozzle holder if applicable.
7. Gently feed the liner down through the bicox cable from the machine end of the torch, taking special care not to kink it in the process. Once the liner reaches the back of the swan neck it may be necessary to gently twist it through.
8. With the liner now fully home, replace the liner positioning nut. **DON'T OVER TENSION.** At the front end of the torch there will now be approximately 300mm of liner protruding from the swan neck.
9. Gently stretch the liner a further 4mm and cut at the tip of the neck with a sharp pair of cutters. The liner will now spring back into the swan neck by 4mm.
10. Refit tip holder, tip and nozzle.

SETTING UP FOR OPERATION

1. Fit Torch To Machine

Carefully align gas connection tube and trigger connection pins with central adaptor. Push in and tighten the lock nut.

Open the wire feed pressure arm (FIG. 1) above the feed roll.

Fit the feed roll to suit the diameter of wire to be used.

2. Feed Roll Changing (if required)

Remove the feed roll retaining knob. Pull off feed roll. When replacing the feed roll, note the wire size which is stamped on the face of the roll. The required size must face inwards when the roll is re-fitted. Ensure that the Woodruff Key is not lost.

Fit the feed roll and refit the retaining knob using thumb and forefinger. **DON'T OVER TIGHTEN.**

3. Fit The Reel Of Welding Wire

Remove the red hand nut from hub.

Place the reel of wire on hub so that the wire will be drawn off the bottom.

Ensure that the pin on the hub locates in the hole in the side of the wire reel spool reel. Replace red hand nut.

4. Overrun Adjustment

Tighten or unscrew the hub tension nut in the centre of the hub reel assembly unit until sufficient hub friction is achieved to prevent overrun. This adjustment should be done with a full spool of wire at maximum wire feed speed. **DON'T OVER TIGHTEN.**

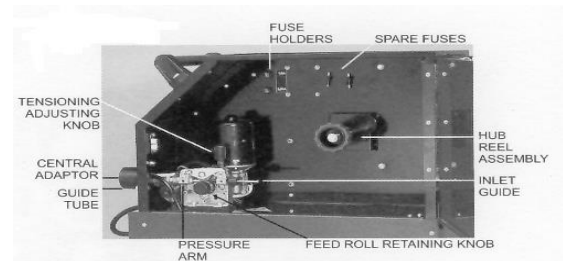

FIGURE 1.

5. Feed Roll Adjustment

Release the wire end from reel and cut off the bent wire end, taking care that the wire does not unwind. Remove the nozzle and contact tip from the welding gun. Straighten about 20cm of the wire and make sure that the end is as blunt as possible (file off if necessary). A sharp end could damage the cable liner and the contact tip of the welding torch. Ensure the wire is placed correctly on to the feed rolls.

6. Feed Roll Alignment



FIGURE 2.

To adjust, release the three screws holding motor drive assembly and lower or raise to achieve correct alignment. (FIG 2.) Thread some wire through the feed rolls into the guide tube and liner of the welding cable. Close the wire feed pressure arm. The pressure adjustment of the feed rolls must be set so that the wire is fed evenly into the liner and light restriction of the wire can be made without the feed rolls slipping.

NOTE: Excessive pressure will cause flattening of the wire, loosening of the wire coating and undue wear of the rolls.

Switch on machine and set the wire feed speed dial on a low setting. Keep the cable of the welding torch straight and press the switch on the torch until the wire end comes out of the gooseneck.

Replace the contact tip and nozzle.

7. Earth Connection

The earth connection from the welder should always be made directly on to the piece to be welded. The contact between the earth and the job should be as large and as flat as possible and all rust and paint on the work piece should be removed. Connect the earth cable to the earth connection socket (5). The MIGOMAG 260AND 400 Classic have two connection sockets: (5i) is for very light welding applications and (5ii) is for heavier welding applications.

Fit hose tail and nut to the gas hose and hold captive with the hose clamp, found in the wire feed compartment of the machine adjacent to the wire feed rolls. Connect the gas hose to the regulator, open the cylinder valve and adjust gas flow rate. (see Shielding Gas for flow rates).

PLUG MUST BE FITTED BY A QUALIFIED ELECTRICIAN.

MACHINE CONTROLS

1. ON/OFF Switch

With this switch in the ON position, power is applied to the fan and control circuits.

WARNING: THIS SWITCH DOES NOT ISOLATE THE UNIT FROM THE MAINS ELECTRICAL SUPPLY.

2. T1 – 'ON' TIME CONTROL for SPOT welding and STITCH 'ON' time.
3. T2 – 'OFF TIME CONTROL for STITCH "OFF" time.
4. WIRE FEED SPEED (Current Control).
5. NEGATIVE CONNECTION
 - i. Inductance Socket – Low
 - ii. Inductance Socket – Med/High
 - iii. Inductance Socket – High
6. VOLTAGE SELECTOR SWITCH Fine.
7. CENTRAL ADAPTOR.
8. VOLTAGE SELECTOR SWITCH Course.
9. POSITIVE CONNECTION.
10. BURNBACK CONTROL (375)

Welding Voltage Adjustment

MIGOMAG 260

The welding voltage is regulated by a 2-position switch for course control and a 8-position switch for fine control, a total of 16. Position (8) and (6) on the front panel.

MIGOMAG 400

The welding voltage is regulated by a 6-position switch for course control and a 6-position switch for fine control, a total of 36. Position (8) and (6) on the front panel.

Warning: If the welding voltage is set too high, the weld can burn through light guage sheet metal. In this case the voltage should be reduced. If set too low, the weld will have little penetration and will just "sit on" the plate.



FIGURE 3.

Wire Feed Speed

The wire feed speed is regulated from 0-18m/min by the potentiometer dial (4) above the voltage switch.

It is most important to select the wire feed speed in relation to the voltage setting. The correct wire feed speed/voltage setting is recognisable by:

1. A continuous regular 'crackling' sound when welding, the characteristics of dip transfer or short-arc welding method normally used by small/medium sized MIG/MAG welders.
2. A correct shape weld bead not too high, or low, with correct fusion along the edge of the weld without undercut in the heat-affected zone.

Welding Mode Switch/Timer

Both 't1' and 't2' controls are used to control the welder ON/OFF times during stitch welding and 't1' is used alone to control spot welding time (ON).

For normal continuous (trigger controlled) welding, ensure both 't1' and 't2' controls are turned fully anticlockwise to the OFF positions.

Protection Device

Protection against the effects of overheating is provided by thermal protection devices mounted on the transformer assembly.

In the event of overheating, power to the unit is interrupted.

The protection device automatically resets once the unit cools.

SHEILDING GAS

The gas provides a shield over the weld pool to prevent contamination from the surrounding air. The shielding gas also contributes to arc stability, weld strength and appearance, so care should be taken to ensure that the correct gas type/mixture is selected for the metal being welded. (Refer table page 10)

The gas flow rate, adjusted by the regulator, increases with variations in welding gun diameter and should be 15 litres per minute for the MB24 welding gun to 25 litres per minute for the MB36 welding gun with cylindrical nozzle.

Excessive gas flow rates should be avoided as they are wasteful and, in some instances, can cause weld porosity.

WORK ENVIRONMENT

The machine should be used indoors away from strong draughts which may cause gas dissipation.

If the machine is to be covered, the natural cooling air circulation must not be interrupted.

Before commencing welding, clear area of flammable materials.

OPERATION

1. Continuous Welding

Ensure that both timer switches 't1' and 't2' are in the 'OFF' position.

Set the voltage and wire feed controls to positions suitable for welding the thickness of the material being welded.

Welding current varies in direct relationship to wire feed speed.

For low welding current output, the wire feed speed control should be set at the low end of the wire feed speed scale.

Turning the wire feed speed control knob clockwise will result in increased wire feed speed and welding current. Welding voltage is adjusted to match the wire feed speed (welding current).

For welding in the low current range, set both voltage switches to position number (1).

These MIGOMAG machines have two voltage selection switches, a course control (8) and fine voltage selection (6).

Progressively select higher voltage positions with increases in wire feed speed.

Low wire feed speed settings for a given voltage will cause a large ball to form on the end of the welding wire and cause excessive spatter.

High wire feed speed settings for a given voltage will cause wire stubbing.

Position the torch over the seam to be welded with the nozzle approximately 70° to the work surface.

The nozzle to work distance should be approximately 10mm.

WARN BYSTANDERS TO SHIELD THEIR EYES.

Lower your helmet and press the welding gun trigger switch to initiate an arc.

As the weld is deposited, push the torch from right to left direction, slowly along the seam at a constant speed.

Using the wire feed speed control, adjust for a "crisp" sounding arc.

2. Spot Welding

MIG spot welding is made from one side of the sheets placed upon another so that the high welding current penetrates through the upper sheet (max. 1.5mm) and a part of the lower sheet.

A circular spot is produced each time the torch trigger is pressed. The spot weld time 't1' can be varied.

Select 'spot' welding by turning switch 't1' only.

Fit spot weld nozzle to the torch.

Set voltage and wire feed speed controls to near maximum settings and carry out test welds on scrap materials as follows:

Position the legs of spot-welding nozzle over weld position and depress torch trigger switch. At the termination of the weld, check for weld penetration (small dimple showing on underside of weld), and adjust spot weld time for best results.

When welding sheets of unequal thickness, the thinner sheet must be on top. Thicker sheets can be welded together by drilling a hole in the top sheet and directing the wire into hole – this is known as 'plug welding'.

Spot welding requires ONLY LIGHT PRESSURE; the sheets are pressed against each other with the legs of the welding nozzle.

3. Stitch Welding

The wire feed output is switched on and off repeatedly. This produces a lower heat input which is particularly advantageous when welding thin or poor-quality materials as well as bridging gaps.

Select 'stitch' welding by turning 't1' and 't2' controls to the halfway setting. Vary time to obtain the best results. They do not have to be equal.

't1' controls the welding or working cycle.

't2' controls the pause cycle between welding.

Note: The trigger on the gun must be kept depressed during both cycles.

Welding occurs during the working (ON) cycle; During the pause cycle, the wire feed STOPS, and the arc will extinguish. During the pause cycle the molten pool will cool down. The arc will ignite again automatically at the beginning of the following working cycle when the filler wire makes contact with the molten pool. The welding current is automatically switched on and off and the shielding gas supply will remain on during the pause cycle.

Note: Spot welding and stitch welding of aluminium is not possible.

SETTING UP GUN FOR ALUMINIUM WELDING

1. The Welding Gun

Remove the liner positioning nut from the adaptor block at the wire feed end of the gun cable. Remove the gas nozzle, contact tip holder, gas diffuser/contact tip from the welding torch and remove existing liner if fitted.

Carefully push the teflon liner with, brass neck liner attached, through the gun cable until the end of the liner protrudes from the swan neck and withdraw the liner back into the swan neck.

Adjust the contact tip holder, gas diffuser/contact tip and gently push the liner to seat it into the back of the contact tip holder/contact tip. Replace the gas nozzle.

At the adaptor block end of the gun cable, slide the brass nipple and 'O' ring over the liner until they are located in the recess in the adaptor block and replace the liner retaining nut.

DO NOT CUT THE TEFLON LINER YET!!!!

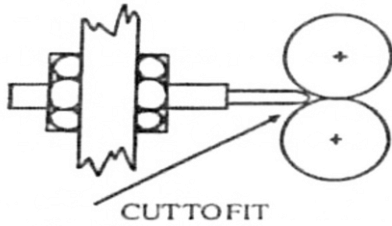

FIGURE 4.

2. The Welding Machine

With a pair of long nosed pliers, remove the steel inlet guide tube from the central adaptor on the front face of the welding machine. With the teflon liner still protruding from the adaptor block, feed the liner through the inlet of the central adaptor until the adaptor block is butted against the central adaptor. Fasten into position with adaptor block lock nut.

Cut the liner in the shape of a 'V', using a sharp knife so that it butts up to the feed rollers as pictured. (FIG 4.)

Remove the welding gun from the machine and cut the brass support tube so that it is 3mm shorter than the protruding teflon liner. Slide the brass support tube over the liner and enter the teflon liner with brass support tube fitted into the inlet in the central adaptor, feed through until the adaptor block is butted against the central adaptor and tighten the lock nut.

Reduce the wire hub tension by backing off the nut in the centre of the hub until the nut is positioned at the end of the stud.

After confirming the wire feed roll is correct size for the aluminium wire being used, and that the wire is fed through the gun cable, back off the wire feed roll pressure screw until the feed roll no longer feeds the wire and re-tighten approximately 2 turns. Too much pressure will deform the soft aluminium wire and cause the wire to jamb in the contact tip.

Note: To help prevent deformation: a 'U' groove feed roller is a better alternative than a 'V' groove feed roller.

3. Contact Tip

Aluminium welding requires a contact tip with greater clearance than that used for steel. Special clearance contact tips are available for welding aluminium and are designed with an A suffix. E.g. 0.9A, 1.2A.

PARTS LIST

PART NUMBER	DESCRIPTION
1260005	Teflon Liner 1.0mm
1260021	Teflon Liner 1.2mm
1290461	Brass Support Tube for Teflon Liner
1310001	Nipple for Teflon Liner
86003033	Drive Roll 0.9/1.0-1.2mm Al
86003066	Drive Roll 0.9/1.0-1.2mm Al
1410004	Contact Tip 0.9mm Aluminium
1410006	Contact Tip 1.0mm Aluminium
1410010	Contact Tip 1.2mm Aluminium
86007001	Brass Neck Liner

WELDING HINTS

Welding with Solid Wires (Steel, Aluminium & Stainless Steel)

The flexible welding cable extending from the wire feed unit should be plugged into the Positive socket and the earth leads plugged into one of the Negative sockets.

Gasless Wire Welding (Flux Cored)

For gasless welding wire requiring reverse polarity, the flexible welding cable extending from the front panel of the machine should be plugged into the Negative socket and the work lead into the Positive socket.

Gasless welding wire requires lower wire feed speeds and voltage when compared to solid wires.

To ensure a positive wire feed, knurled feed rolls appropriate to the wire size being used should be fitted in place of smooth feed rolls.

Aluminium Welding

Select a voltage setting approx. halfway through the low range on your machine e.g.: 1+6 of 12 of 6 or 2+4 of 24.

Set the wire feed speed to approx. 10 and the gas flow meter to approx. 20-25 litres per minute when welding. Remove oxide coating from weldments with a stainless-steel wire brush. Initiate arc and lift the torch nozzle away from the weld pool until the nozzle/weld distance is 12-15 times the diameter of the wire e.g.: 11-14mm for 0.9mm wire. Direction of travel should be from right to left by pushing the gun.

ALWAYS TEST SETTINGS ON A SCRAP PIECE OF MATERIAL FIRST.

Stainless Steel Welding

Always use a clearance size liner e.g.: 1.2mm liner for 0.9mm wire. Wire and voltage feed settings will be similar to those used for welding mild steel. However, the different gas will increase the arc temperature.

Set the gas flow meter to approx. 20 litres per minute. Ensure when welding that the torch nozzle is lifted away from the weld pool until the nozzle/weld pool distance is 12-15 times the diameter of the wire. A clearance size contact tip may be necessary in some situations of high torch heat e.g.: 0.9Amm tip for 0.9mm wire or 1.2Amm tip for 1.2mm wire.

WELDING FAULTS

FAULT	POSSIBLE CAUSE & REMEDY
Weld deposit 'stringy' and incomplete	<ol style="list-style-type: none"> 1. Torch moved over work piece too quickly 2. Gas mixture incorrect
Weld deposit too thick	<ol style="list-style-type: none"> 1. Torch moved over work piece too slowly 2. Welding voltage too low
Arc unstable, excessive spatter and weld porosity	<ol style="list-style-type: none"> 1. Torch held too far from the workpiece 2. Rust, grease or paint on workpiece 3. Insufficient shielding gas: check gas contents gauge, regulator setting and operation of gas valve
Wire repeatedly burns back	<ol style="list-style-type: none"> 1. Torch held too close to the workpiece 2. Intermittent break in the welding circuit caused by: <ol style="list-style-type: none"> i Contact tip loose - tighten ii Contact tip damaged – replace iii Welding wire or liner corroded – replace wire or liner 3. Wire feed slipping cause by: <ol style="list-style-type: none"> i Restriction in liner (such as kinks) or contact tip – check and replace if necessary ii Worn feed rolls – replace iii Guide tube or pressure roll alignments incorrect
Burning holes in the workpiece	<ol style="list-style-type: none"> 1. Torch moved too quickly or erratically 2. Welding volts too high 3. Wire feed speed too high
Lack of penetration	<ol style="list-style-type: none"> 1. Torch moved too fast 2. Welding volts too low 3. Wire feed speed too low

SPOT WELDING FAULTS

FAULT	POSSIBLE CAUSE & REMEDY
Insufficient penetration	<ol style="list-style-type: none"> 1. Spot weld time too short 2. Gap between metals to be joined too wide 3. Switch position too low 4. Welding settings too low
Holes burnt through workpiece	<ol style="list-style-type: none"> 1. Spot weld time too long 2. Gap between metals to be joined too wide 3. Weld is too close to the edge of the material 4. Welding settings too high
Wire sticks to contact tip or workpiece at end of the weld	<ol style="list-style-type: none"> 1. Burn off time incorrect – expert assistance required since burn back must be accurately timed
Wire burns back	<ol style="list-style-type: none"> 1. Poor gas coverage 2. Burn back time incorrect

SAFETY

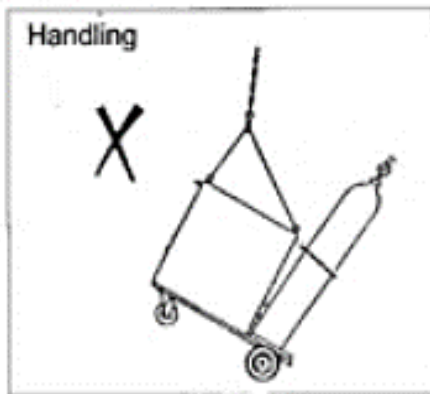

Remove cylinder before lifting

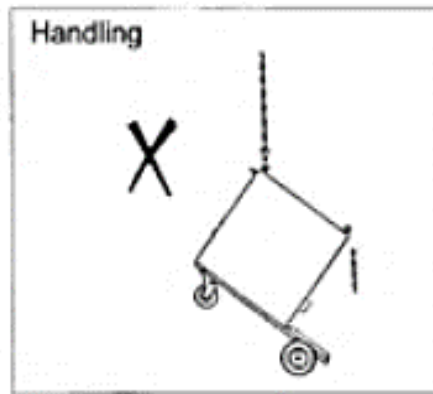

Do not lift using handle

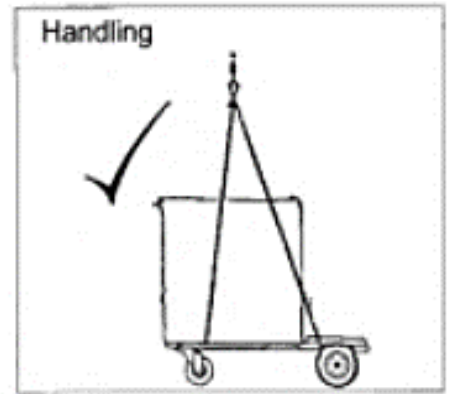

Lift the unit correctly

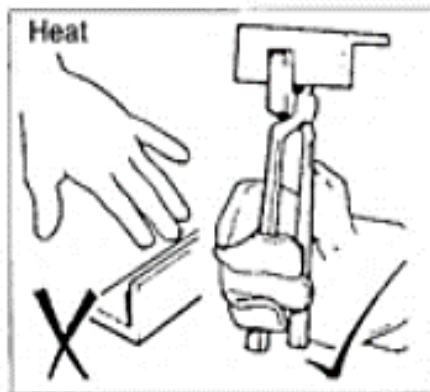

Don't burn yourself!
Wear gauntlets and use tongs

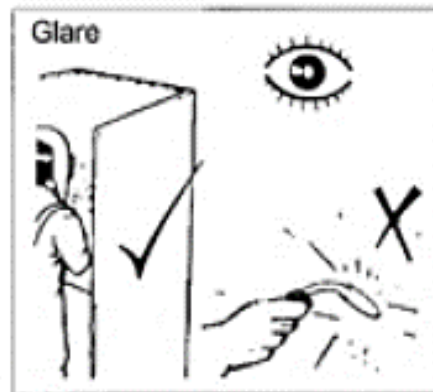

Wear your headshield (or face screen)
and screen the welding area

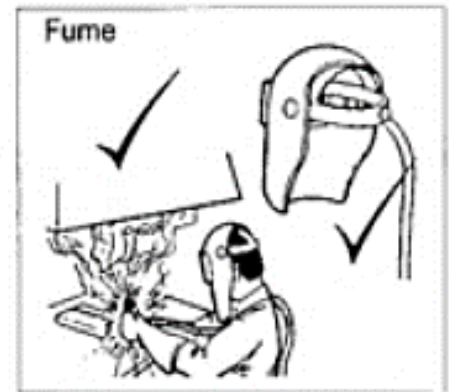

Ventilate the welding area to prevent a
build-up of gas and fumes

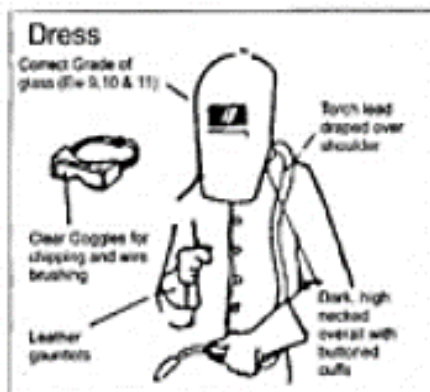

Dress correctly when welding and
preparing the weld



Wear goggles and mask when removing
dust with an airline



Before commencing welding, clear the
area of flammable materials

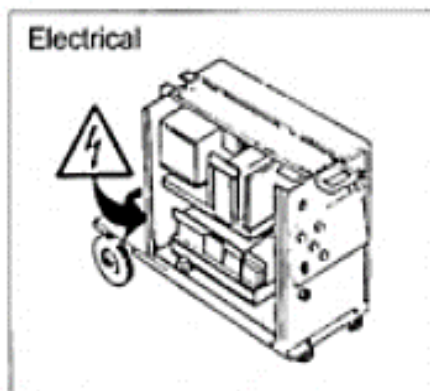

Don't work with the cover off.
Leave it to the experts

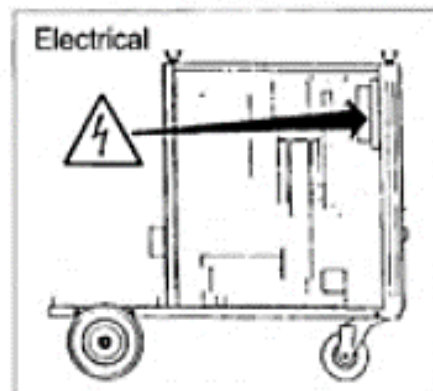

415/240V a.c. is supplied to
the p.c.b. Isolate unit before
removing covers of p.c.b.

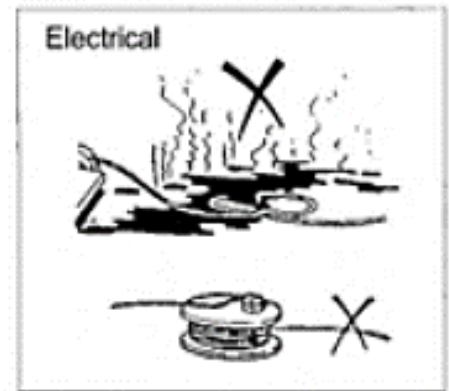

Don't allow leads to lie in oil, water or
corrosive liquid or extend them with
extension leads - fit a longer cable

SAFETY

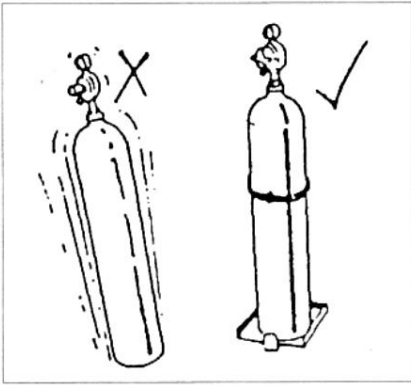

Support the gas cylinder with chain provided.

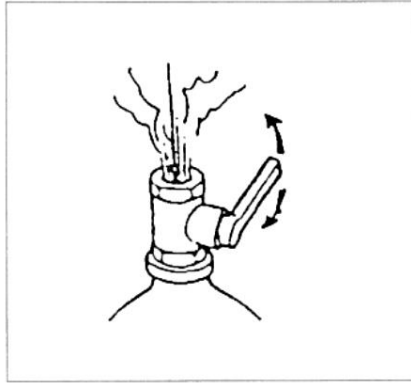

Protect eyes and open cylinder valve to remove any dirt in valve socket.

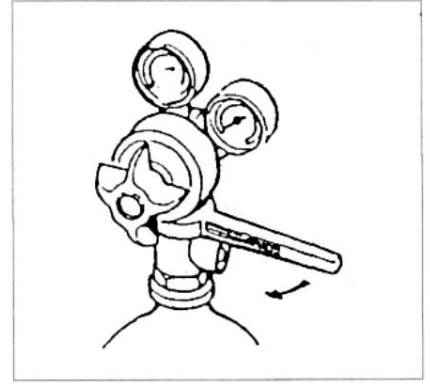

Fit gas regulator to cylinder and hand tighten using correct size spanner. DON'T OVERTIGHTEN 'O' RING, provides seal.



Open cylinder valve and check the cylinder pressure (Must be greater than 10bar (150lb/in²)).

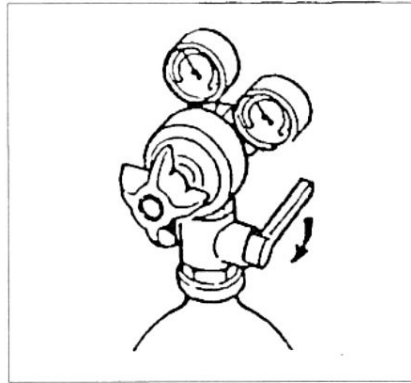

Close cylinder valve.

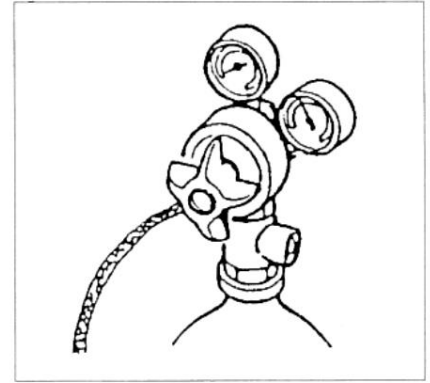

Fit gas hose to regulator and open cylinder valve. Set flow to 15 Lt Min. Larger torch may need 20 Lt Min.

Clean the material to be welded with a wire brush.

Place the earth lead clamp on a clean area of the work piece.

Keep the gap between pieces to be welded to a minimum.

Clear the welding area and check that a fire extinguisher is available.

Ensure a fire extinguisher is nearby in case of fire

Preparation

SHEILDING GAS TABLE MIG WELDING

Metal	Gas	Remarks
Mild Steel	Argon + CO2 Argon + CO2 + Oxygen	Argon controls spatter Oxygen improves arc stability
Aluminium	Argon Argo Helium	Stable arc – sound welds Higher heat input suitable for heavy sections
Stainless Steel	Argon + CO2 + Oxygen Argon + Oxygen	Arc stability Minimum spatter
Copper, Nickel & Alloys	Argon Argon Helium	Suitable for light gauges Higher heat input Suitable for heavy sections

STANDARD WELDING GUN LIST

MIG WELDER MODEL	STANDARD GUN WITH 3M CABLE
MIGOMAG 260 MIGOMAG 400	MB24KD MB36KD

MIGOMAG 260 COMPACT MACHINE BREAKDOWN & PARTS DESCRIPTION

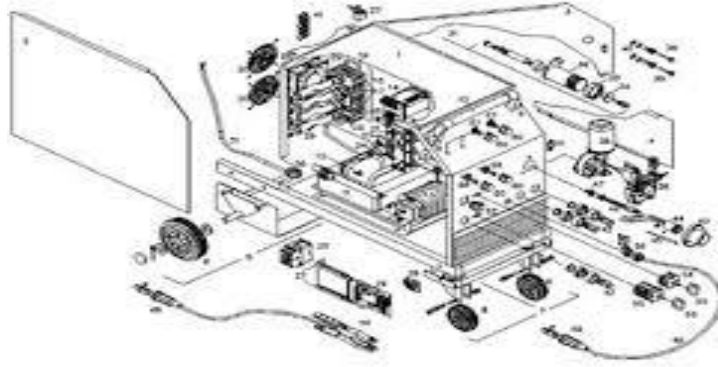

FIG	PART NO.	DESCRIPTION	FIG	PART NO.	DESCRIPTION
2	86001017	Left Hand Side Panel	31	86003011	Hub Complete
3	86001070	Opening Side Panel	32	86003012	Hub Only
4	86001069	Right Hand Side Panel Lower	33	86003010	Hub Nut
5	86001041	Rear Wheel Assy	34	86006050	Friction Brake Washer
6	86001038	Rubber Wheel Dia. 160mm	35	86003003	Drive Motor
7	86001048	Front Whhel Assy	36		Wire Feed Unit
8	86001051	Rubber Wheel Dia. 100mm		86003004	Drive Bracket Assy
9	86001082	Handle Support Bracket	37	86006001	Gas Soleniod Valve 230V
10	86001083	Handle Pipe	38	86002052P	Fuse 1AMP 20 x 5 (10pkt)
11	86004033	Transformer Main	39	86002050P	Fuse 1AMP 30 x 6 (10pkt)
12	86001031	Thermoswitch 110C for Main Transformer	40	86002070	Fuse Holder 30 x 6
13	86004005	Choke	42	P5110014	Dinse Socket 35
14	86004014	Transformer Auxilary	43	5010616	Housing For Central Adapter
16	86005001	Diode IR	43-47	86003001	Central Adapter Head
16	86005000	Diode 2003	45	86003041	Guide Tube 1.0 x 1.2mm
17	86005012	Heatsink M20 x 1.5	48	P5110015	Dinse Plug 35
18	86005012A	Heatsink M20 x 1.5 + M4	49	FW35	Rubber Cable 35mm2
19	86005013	Heatsink Holder	50	MEC500	Earth Clamp
20	86001031A	Thermoswitch 80C	52	86001005	Switch ON/OFF
21	86001024	Capacitor Unit Complete	53	86001046	Knob for Voltage Switch
22	86001020	Capacitor	54	86001013	Switch 2 Position
23	86001032	Bleed Off Resistor	55	86001014	Switch 8 Position
25	86001016	Main Conttactor	57	86001043	Spot Pot 470KA
26	86002010	PCB	58	86001044	Wire Feed Pot 10KA
27	86002007	PCB Holder	59	86001047	Burnback Pot 4K7A
29	86001030	Fan	60	86001045	Complete Knob for Pot/meter
30	86001029	Fan Guard			

MIGOMAG 400 COMPACT MACHINE BREAKDOWN & PARTS DESCRIPTION

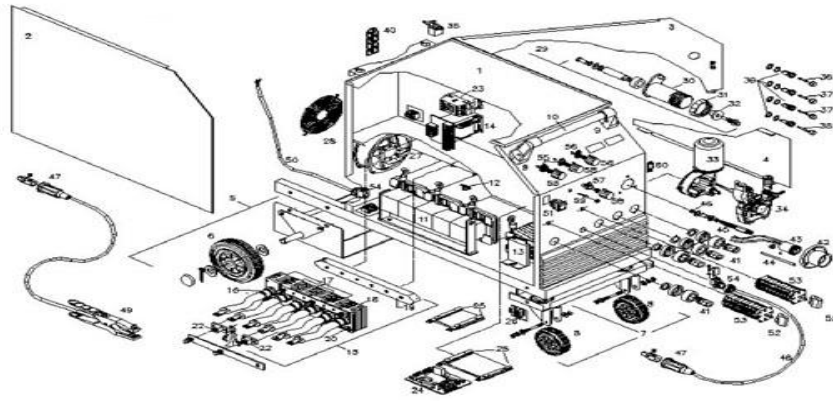

FIG	PART NO.	DESCRIPTION	FIG	PART NO.	DESCRIPTION
2	86001076	Left Hand Side Panel	30	86003012	Hub Only
3	86001075	Opening Side Panel	31	86003010	Hub Nut
4	86001074	Right Hand Side Panel Lower	32	86006050	Friction Brake Washer
5	86001042	Rear Wheel Assy	33	86003003	Drive Motor
6	86001038	Rubber Wheel Dia. 160mm	34		Wire Feed Unit
7	86001049	Front Wheel Assy		86003004	Drive Bracket Assy
8	86001051	Rubber Wheel Dia. 100mm	35	86006002	Gas Solenoid Valve
9	86001082	Handle Support Bracket	36	86002062P	Fuse 6.3AMP 30 x 6 (10pkt)
10	86001084	Handle Pipe	37	86002054P	Fuse 2.5AMP 30 x 6 (10pkt)
11	86004030	Transformer Main	38	86002052P	Fuse Holder 1AMP 20 x 5 (10pkt)
12	86001031	Thermoswitch 110C for Main Transformer	39	86002070	Fuse Holder
13	86004007	Choke	41	P5110014	Dinse Socket 35
14	86004013	Transformer Auxiliary	42	5010616	Housing For Central Adapter
16	86005001	Diode IR	42-46	86003001	Central Adapter Head
16	86005000	Diode 2003	44	86003044	Guide Tube 2.0mm
17	86005012	Heatsink M20 x 1.5	47	P5110015	Dinse Plug 35
18	86005012A	Heatsink M20 x 1.5 + M4	48	FW35	Rubber Cable 35mm ²
19	86005013A	Heatsink Holder	49	MEC500	Earth Clamp
20	86001031A	Thermoswitch 80C	51	86001005	Switch ON/OFF
23	86001019A	Main Contactor	52	86001046	Knob for Voltage Switch
24	86002010	PCB	53	86001006	Switch 6 Position
25	86002007	PCB Holder	55	86001043	Spot Pot 470KA
27	86001028	Fan	56	86001044	Wire Feed Pot 10KA
28	86001029A	Fan GuardB	57	86001047	Burnback Pot for 4K7A
29	86003011	Complete Hub	58	86001045	Complete Knob for Pot/Meter

WARRANTY

MIGOMAG WELDING SUPPLIES warrants NEW Migomag MIG welding machines against defects in material or manufacture, provided machines are used within the Migomag published specification limits.

Within the limits of the warranty defective part will be replaced by a new part, or, where possible, the defective part will be repaired free of charge.

The warranty does not compensate for damage due to improper use, neglect or normal wear.

Travelling costs, freight or postage charges are not covered by the warranty.

Warranty repairs must be carried out at the premises of Migomag Welding Supplies or its authorised Service Repatr Agent. Repairs by unauthorised persons will void this warranty.

The warranty period is effective from the date of purchase for the following periods:

- Main Transformers & Choke 3 years
- Auxiliary Transformer & Rectifier 3 years
- AU Other Components of the Welding Machine 1 year

Welding guns, gas flowmeters and accessories are NOT included in this warranty.

Contact: warranty@migomag.com.au



668 Somerville Rd
Sunshine VIC 3020
Ph 03 9313 3100
Fax 03 9312 4499

63 Douro St
Nth Geelong VIC 3215
Ph 03 5240 5600
Fax 03 5277 9836

info@migomag.com.au
www.migomag.com.au

YOUR WELDING INDUSTRIAL SPECIALISTS

Lawvale Pty Ltd trading as:

MIGOMAG WELDING SUPPLIES

A.B.N. 50 007 120 603

**THE LARGEST INDEPENDENT WELDING
EQUIPMENT SUPPLIER IN AUSTRALIA**

668 Somerville Road Sunshine Victoria 3020

Phone: 03 9313 3100 Fax: 03 9312 4499

63 Douro Street North Geelong Victoria 3215

Phone: 03 5240 5600 Fax: 03 5277 9836

Email: info@migomag.com.au

www.migomag.com.au